



User's Guide

Multimedia Projector

EB-1960

EB-1950



EB-1940W

EB-1930





Notations Used in This Guide

- **Safety indications**

The documentation and the projector use graphical symbols to show how to use the projector safely. Please understand and respect these caution symbols in order to avoid injury to persons or property.

| | |
|--|--|
|  Warning | This symbol indicates information that, if ignored, could possibly result in personal injury or even death due to incorrect handling. |
|  Caution | This symbol indicates information that, if ignored, could possibly result in personal injury or physical damage due to incorrect handling. |

- **General information indications**

| | |
|---|---|
| Attention | Indicates procedures which may result in damage or injury if sufficient care is not taken. |
|  | Indicates additional information and points which may be useful to know regarding a topic. |
|  | Indicates a page where detailed information regarding a topic can be found. |
|  | Indicates that an explanation of the underlined word or words in front of this symbol appears in the glossary of terms. See the "Glossary" section of the "Appendix".  "Glossary" p.140 |
| [Name] | Indicates the name of the buttons on the remote control or the control panel. Example: [Esc] button |
| Menu Name | Indicates Configuration menu items. Example: Select Brightness from Image . Image - Brightness |

Notations Used in This Guide 2

Introduction

Projector Features 8

| | |
|---|----|
| Quick and Easy Set up, Projection, and Storage | 8 |
| Connecting with a USB cable and projecting (USB Display) | 8 |
| Detecting projector movements and automatically correcting image distortion | 8 |
| Horizontal keystone adjuster | 8 |
| Useful Functions for Projecting Images | 8 |
| Project two images simultaneously (Split Screen) | 8 |
| Increasing projection content in wide (WXGA) screen (EB-1940W only) | 9 |
| Making the most of the remote control | 9 |
| Enlarge and project your files with the Document Camera | 9 |
| Connect a USB storage device and project PDFs, movies, and images (Slideshow) | 9 |
| Enhanced security functions | 9 |
| Optimum color mode for projecting medical images | 9 |
| Precise color adjustments | 10 |
| Taking Full Advantage of a Network Connection | 10 |
| Connecting to a network and projecting images from the computer's screen | 10 |
| Projecting images from portable devices over a network | 10 |
| Easy connection to a computer with Quick Wireless Connection | 10 |

Part Names and Functions 11

| | |
|--|----|
| Front/Top | 11 |
| Rear | 12 |
| Base | 13 |
| Control Panel | 14 |
| Remote Control | 15 |
| Replacing the remote control batteries | 17 |
| Remote control operating range | 18 |

Preparing the Projector

Installing the Projector 20

| | |
|---|----|
| Installation Methods | 20 |
| Installation methods | 20 |
| Screen Size and Approximate Projection Distance | 21 |

Connecting Equipment 23

| | |
|-------------------------------|----|
| Connecting a Computer | 23 |
| Connecting Image Sources | 24 |
| Connecting USB Devices | 25 |
| Connecting External Equipment | 27 |
| Connecting a LAN Cable | 28 |

Basic Usage

Projecting Images 30

| | |
|---|----|
| From Installation to Projection | 30 |
| Automatically Detect Input Signals and Change the Projected Image (Source Search) | 31 |
| Switching to the Target Image by Remote Control | 32 |
| Projecting with USB Display | 32 |
| System requirements | 32 |
| Connecting for the first time | 33 |
| Uninstalling | 34 |

Adjusting Projected Images 36

| | |
|--|----|
| Correcting Keystone Distortion | 36 |
| Correcting automatically | 36 |
| Correcting manually | 37 |
| Adjusting the Image Size | 40 |
| Adjusting the Image Position | 40 |
| Adjusting the Horizontal Tilt | 40 |
| Correcting the Focus | 41 |
| Adjusting the Volume | 41 |
| Adjusting the Image | 41 |
| Hue, Saturation, and Brightness Adjustment | 41 |

| | |
|---|----|
| Gamma Adjustment | 42 |
| Selecting the Projection Quality (Selecting Color Mode) | 43 |
| Setting Auto Iris | 44 |
| Changing the Aspect Ratio of the Projected Image | 44 |
| Changing methods | 45 |
| Changing the aspect mode | 45 |

Useful Functions

| | |
|--|-----------|
| Projection Functions | 49 |
| Projecting Two Images Simultaneously (Split Screen) | 49 |
| Input sources for split screen projection | 49 |
| Operating procedures | 50 |
| Restrictions during split screen projection | 52 |
| Projecting Without a Computer (Slideshow) | 53 |
| Specifications for files that can be projected using Slideshow | 53 |
| Slideshow examples | 53 |
| Slideshow operating methods | 54 |
| Projecting the selected images or movies | 56 |
| Projecting PDF files | 57 |
| Projecting image files in a folder in sequence (Slideshow) | 58 |
| Playing a scenario | 59 |
| Operations while playing a scenario | 59 |
| Image file display settings and Slideshow operation settings | 60 |
| Hiding the Image and Sound Temporarily (A/V Mute) | 61 |
| Freezing the Image (Freeze) | 61 |
| Pointer Function (Pointer) | 62 |
| Enlarging Part of the Image (E-Zoom) | 63 |
| Using the Remote Control to Operate the Mouse Pointer (Wireless Mouse) | 64 |
| Correcting the Color Difference when Projecting from Multiple Projectors | 65 |
| Summary of correction procedure | 65 |
| Setting an ID and using the remote control | 65 |
| Correcting | 67 |
| Saving a User's Logo | 68 |
| Security Functions | 70 |
| Managing Users (Password Protect) | 70 |

| | |
|--|----|
| Kinds of Password Protect | 70 |
| Setting Password Protect | 70 |
| Entering the Password | 71 |
| Restricting Operation (Control Panel Lock) | 72 |
| Anti-Theft Lock | 73 |
| Installing the wire lock | 73 |

Monitoring and Controlling 74

| | |
|---|----|
| About EasyMP Monitor | 74 |
| Changing Settings Using a Web Browser (Web Control) | 74 |
| Projector setup | 74 |
| Displaying the Web Control screen | 75 |
| Displaying the Web Remote screen | 75 |
| Using the Mail Notification Function to Report Problems | 76 |
| Reading Error Notification Mail | 77 |
| Management Using SNMP | 77 |
| ESC/VP21 Commands | 78 |
| Command list | 78 |
| Cable layouts | 78 |
| About PJLink | 79 |
| About Crestron RoomView® | 80 |
| Operating a projector from your computer | 80 |

Configuration Menu

Using the Configuration Menu 85

List of Functions 86

| | |
|-------------------------------------|----|
| Configuration Menu Table | 86 |
| Network menu | 87 |
| Image Menu | 87 |
| Signal Menu | 88 |
| Settings Menu | 90 |
| Extended Menu | 91 |
| Network Menu | 93 |
| Notes on operating the Network menu | 94 |
| Soft keyboard operations | 94 |

| | |
|------------------------------------|-----|
| Basic menu | 95 |
| Wired LAN menu | 96 |
| Mail menu | 96 |
| Others menu | 98 |
| Reset menu | 99 |
| Info Menu (Display Only) | 99 |
| Reset Menu | 100 |

Troubleshooting

| | |
|---|------------|
| Using the Help | 102 |
| Problem Solving | 104 |
| Reading the Indicators | 104 |
| When the Indicators Provide No Help | 107 |
| Problems Relating to Images | 108 |
| No images appear | 108 |
| Moving images are not displayed | 109 |
| Projection stops automatically | 109 |
| The message Not supported is displayed | 109 |
| The message No Signal is displayed | 109 |
| Images are fuzzy, out of focus, or distorted | 110 |
| Interference or distortion appear in images | 111 |
| The mouse cursor flickers (only when projecting USB Display) | 111 |
| The image is truncated (large) or small, the aspect is not suitable, or the image has been reversed | 112 |
| Image colors are not right | 112 |
| Images appear dark | 113 |
| Problems when Projection Starts | 113 |
| The projector does not turn on | 113 |
| Other Problems | 114 |
| No sound can be heard or the sound is faint | 114 |
| The remote control does not work | 115 |
| I want to change the language for messages and menus | 115 |
| Email is not received even if a problem occurs in the projector | 116 |
| Image file names are not displayed correctly in Slideshow | 116 |
| Cannot change settings using a Web browser | 116 |

| | |
|---------------------------------|------------|
| About Event ID | 117 |
|---------------------------------|------------|

Maintenance

| | |
|--|------------|
| Cleaning | 119 |
| Cleaning the Projector's Surface | 119 |
| Cleaning the Lens | 119 |
| Cleaning the Air Filter | 119 |
| Replacing Consumables | 121 |
| Replacing the Lamp | 121 |
| Lamp replacement period | 121 |
| How to replace the lamp | 122 |
| Resetting the lamp hours | 125 |
| Replacing the Air Filter | 125 |
| Air filter replacement period | 125 |
| How to replace the air filter | 125 |

Appendix

| | |
|---|------------|
| Optional Accessories and Consumables | 128 |
| Optional Accessories | 128 |
| Consumables | 129 |
| Screen Size and Projection Distance | 130 |
| Projection Distance (For EB-1960/EB-1950/EB-1930) | 130 |
| Projection Distance (For EB-1940W) | 131 |
| Supported Monitor Displays | 133 |
| Supported Resolutions | 133 |
| Computer signals (analog RGB) | 133 |
| Component Video | 133 |
| Composite video | 133 |
| Input signal from the HDMI port and DisplayPort | 133 |



| | |
|--|------------|
| Specifications | 135 |
| Projector General Specifications | 135 |
| Appearance | 139 |
| Glossary | 140 |
| General Notes | 142 |
| About Notations | 142 |
| Trademarks and Copyrights | 142 |
| Index | 144 |



Introduction

This chapter explains the projector's features and the part names.

Quick and Easy Set up, Projection, and Storage

- Turn the projector on and off by simply plugging in or unplugging.
- Project onto large screens from a short distance.
- Make easy height adjustments with one lever.
- No cool down delay makes it easy to put away.

Connecting with a USB cable and projecting (USB Display)

By simply connecting a USB cable, you can project images from a computer's screen without a computer cable.

☛ "Projecting with USB Display" [p.32](#)

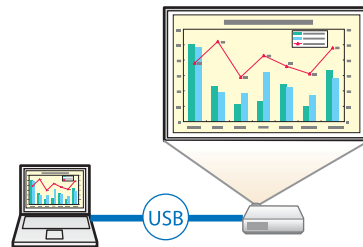

Detecting projector movements and automatically correcting image distortion

This projector automatically corrects vertical keystone distortion which occurs when positioning or moving the projector.

☛ "Correcting automatically" [p.36](#)

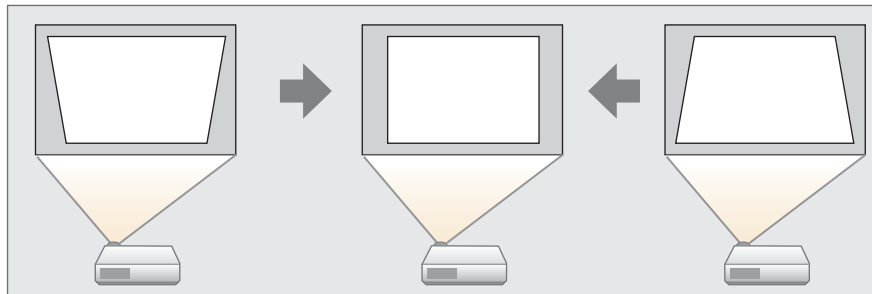

Horizontal keystone adjuster

This allows you to quickly correct horizontal distortion in the projected image. This is useful if you cannot install the projector parallel to the screen.

☛ "Correcting manually" [p.37](#)

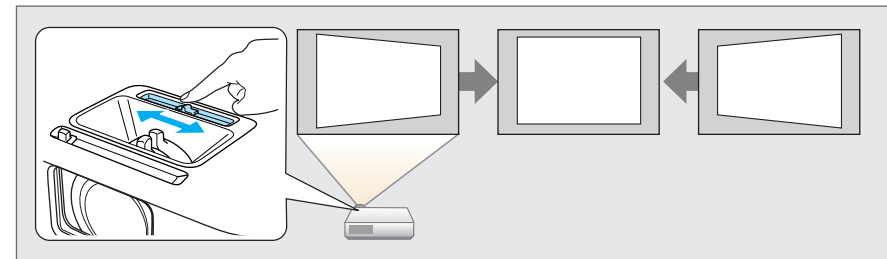

Useful Functions for Projecting Images

Project two images simultaneously (Split Screen)

This function divides the projected screen in two and projects two types of image side-by-side. By simultaneously projecting images from two sources on one screen, you can raise the impact of your message or proposition during video conferences or presentations.

☛ "Projecting Two Images Simultaneously (Split Screen)" [p.49](#)



Increasing projection content in wide (WXGA) screen (EB-1940W only)

With a computer that has a 16:10 WXGA wide LCD display, the image can be projected in the same aspect. You can use whiteboards and other landscape format screens.

☛ "Changing the Aspect Ratio of the Projected Image" [p.44](#)

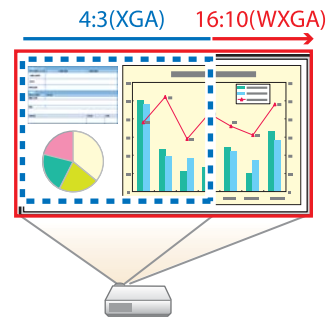

Making the most of the remote control

You can use the remote control to perform operations such as enlarging part of the image. You can also use the remote control as a pointer during presentations or as a mouse for the computer.

☛ "Pointer Function (Pointer)" [p.62](#)

☛ "Enlarging Part of the Image (E-Zoom)" [p.63](#)

☛ "Using the Remote Control to Operate the Mouse Pointer (Wireless Mouse)" [p.64](#)

Enlarge and project your files with the Document Camera

You can project paper documents and objects using the optional Document Camera. Image focus is automatically adjusted using the auto focus function. You can also enlarge images using digital zoom.

☛ "Optional Accessories" [p.128](#)

Connect a USB storage device and project PDFs, movies, and images (Slideshow)

You can connect USB storage devices or digital cameras to the projector and project saved images.

A wide range of file formats are supported such as PDF, movie, and image files.

☛ "Projecting Without a Computer (Slideshow)" [p.53](#)

Enhanced security functions

• Password Protect to restrict and manage users

By setting a Password you can restrict who can use the projector.

☛ "Managing Users (Password Protect)" [p.70](#)

• Control Panel Lock to restrict button operation on the control panel

You can use this to prevent people changing projector settings without permission at events, in schools, and so on.

☛ "Restricting Operation (Control Panel Lock)" [p.72](#)

• Equipped with various anti-theft devices

The projector is equipped with the following types of anti-theft security devices.

- Security slot
- Security cable installation point

☛ "Anti-Theft Lock" [p.73](#)

Optimum color mode for projecting medical images

A color mode called DICOM SIM is provided to project medical images, such as X-ray photographs. This mode produces image quality that approaches the DICOM standard.

(The projector is not a medical device and cannot be used for medical diagnosis.)

☛ "Selecting the Projection Quality (Selecting Color Mode)" [p.43](#)

Precise color adjustments

You can adjust the image's absolute color temperature and the strength of each RGB color. You can also adjust the hue, saturation, and brightness of each RGBCMY to obtain color matching in superior detail.

☛ "Adjusting the Image" [p.41](#)

Taking Full Advantage of a Network Connection

Connecting to a network and projecting images from the computer's screen

You can connect the projector to a computer on a network and project the computer's screen using the supplied EasyMP Network Projection (application software).

☛ [EasyMP Network Projection Operation Guide](#)



Projecting images from portable devices over a network

If "Epson iProjection" is installed on your smart phone or tablet device, you can wirelessly project data from the device. Because you can operate these devices from any location, you can vary the way in which conferences or presentations are made.



You can download "Epson iProjection" for free from the App Store. Any fees incurred when communicating with the App Store are the responsibility of the customer.

Easy connection to a computer with Quick Wireless Connection

By simply connecting the optional Quick Wireless Connection USB Key to a computer, you can project the computer's screen. (Only for Windows computers that support wireless LAN)

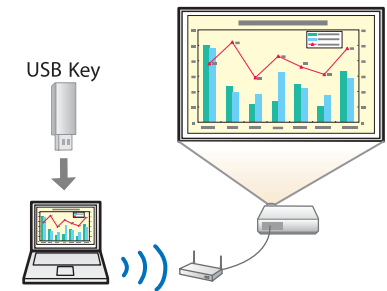

Front/Top

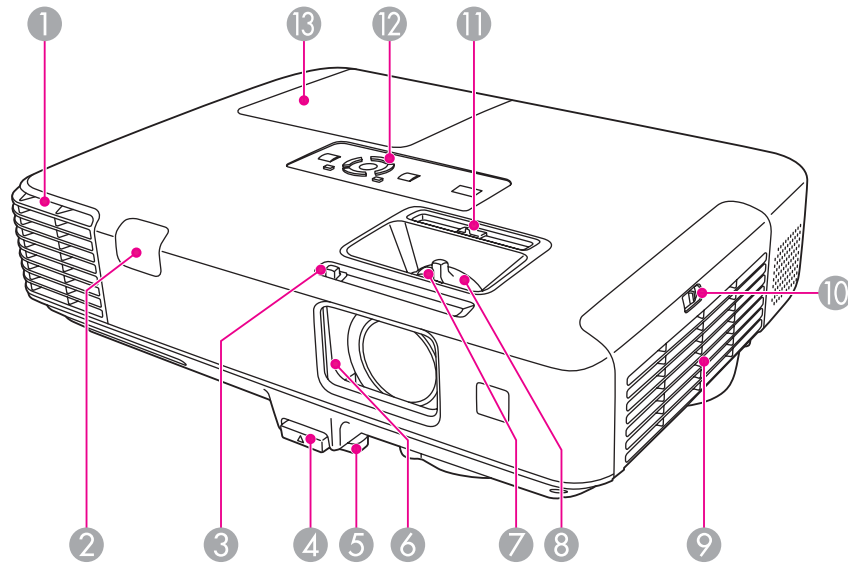

| Name | Function |
|------------------------------|--|
| ① Air exhaust vent | Exhaust vent for air used to cool the projector internally. <div style="border: 1px solid black; padding: 5px; background-color: #ffffcc;"> <p>Caution</p> <p>While projecting, do not put your face or hands near the air exhaust vent, and do not place objects that may become warped or damaged by heat near the vent. Hot air from the air exhaust vent could cause burns, warping, or accidents to occur.</p> </div> |
| ② Remote receiver | Receives signals from the remote control. |
| ③ A/V mute slide knob | Slide the knob to open and close the A/V mute slide. |
| ④ Foot adjust lever | Press the foot adjust lever to extend and retract the front adjustable foot. ⚙️ "Adjusting the Image Position" p.40 |

| Name | Function |
|--|---|
| ⑤ Front adjustable foot | When setup on a surface such as a desk, extend the foot to adjust the position of the image. ⚙️ "Adjusting the Image Position" p.40 |
| ⑥ A/V mute slide | Close when not using the projector to protect the lens. By closing during projection you can hide the image and the sound. ⚙️ "Hiding the Image and Sound Temporarily (A/V Mute)" p.61 |
| ⑦ Focus ring | Adjusts the image focus. ⚙️ "Correcting the Focus" p.41 |
| ⑧ Zoom ring | Adjusts the image size. ⚙️ "Adjusting the Image Size" p.40 |
| ⑨ Air intake vent (air filter) | Takes in air to cool the projector internally. ⚙️ "Cleaning the Air Filter" p.119 |
| ⑩ Air filter cover operation knob | Use this knob to open the air filter cover. ⚙️ "Replacing the Air Filter" p.125 |
| ⑪ H-Keystone Slider | Corrects horizontal distortion in the projected image. ⚙️ "Correcting manually" p.37 |
| ⑫ Control panel | Operates the projector. ⚙️ "Control Panel" p.14 |
| ⑬ Lamp cover | Open when replacing the projector's lamp. ⚙️ "Replacing the Lamp" p.121 |

Rear

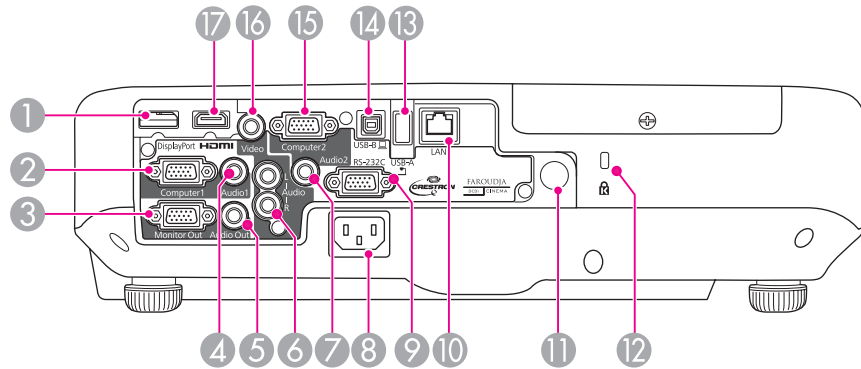

| Name | Function |
|---------------------------|---|
| ① DisplayPort | Inputs video signals from DisplayPort compatible computers. This projector is compatible with HDCP ▶▶. |
| ② Computer1 port | Inputs image signals from a computer and component video signals from other video sources. |
| ③ Monitor Out port | Outputs analog RGB signals input from the Computer1 port to an external monitor. You cannot output signals input from other ports or component video signals. |
| ④ Audio1 port | Inputs audio from equipment connected to the Computer1 port. |
| ⑤ Audio Out port | Outputs audio from the currently projected image to an external speaker. |
| ⑥ Audio-L/R port | Inputs audio from equipment connected to the Video port. |
| ⑦ Audio2 port | Inputs audio from equipment connected to the Computer2 port. |
| ⑧ Power inlet | Connects the power cord to the projector. ☛ "From Installation to Projection" p.30 |

| Name | Function |
|--------------------------|---|
| ⑨ RS-232C port | When controlling the projector from a computer, connect it to the computer with an RS-232C cable. This port is for control use and should not normally be used. ☛ "ESC/VP21 Commands" p.78 |
| ⑩ LAN port | Connects a LAN cable to connect to a network. |
| ⑪ Remote receiver | Receives signals from the remote control. |
| ⑫ Security slot | The security slot is compatible with the Microsaver Security System manufactured by Kensington. ☛ "Anti-Theft Lock" p.73 |
| ⑬ USB(TypeA) port | <ul style="list-style-type: none"> Connects a USB memory device or a digital camera and projects PDFs, movies, or images using Slideshow. ☛ "Projecting Without a Computer (Slideshow)" p.53 Connects the optional Document Camera. |
| ⑭ USB(TypeB) port | <ul style="list-style-type: none"> Connects the projector to a computer via a commercially available USB cable, and projects the images on the computer. ☛ "Projecting with USB Display" p.32 Connects the projector to a computer via the commercially available USB cable to use the Wireless Mouse function. ☛ "Using the Remote Control to Operate the Mouse Pointer (Wireless Mouse)" p.64 |
| ⑮ Computer2 port | Inputs image signals from a computer and component video signals from other video sources. |
| ⑯ Video port | Inputs composite video signals from video sources. |
| ⑰ HDMI port | Inputs video signals from HDMI compatible video equipment and computers. This projector is compatible with HDCP ▶▶. ☛ "Connecting Equipment" p.23 |

Base

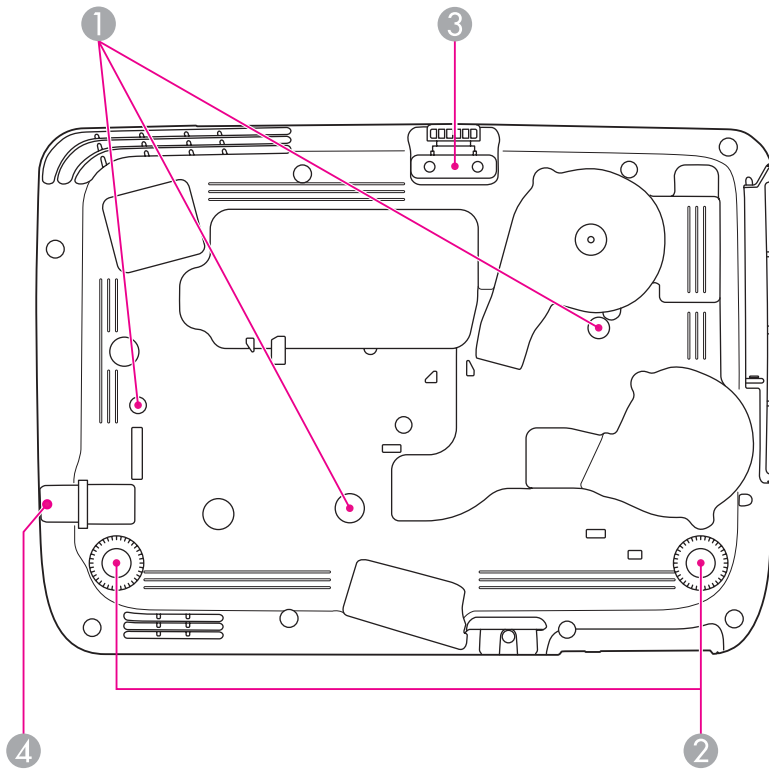

| Name | Function |
|---|---|
| 1 Ceiling mount fixing points (three points) | Attach the optional Ceiling Mount here when suspending the projector from a ceiling. 🖱️ "Installing the Projector" p.20 🖱️ "Optional Accessories" p.128 |
| 2 Rear feet | When setup on a surface such as a desk, turn to extend and retract to adjust the horizontal tilt. 🖱️ "Adjusting the Horizontal Tilt" p.40 |

| Name | Function |
|--|--|
| 3 Front adjustable foot | When setup on a surface such as a desk, extend the foot to adjust the position of the image. 🖱️ "Adjusting the Image Position" p.40 |
| 4 Security cable installation point | Pass a commercially available wire lock through here and lock it in place. 🖱️ "Installing the wire lock" p.73 |

Control Panel

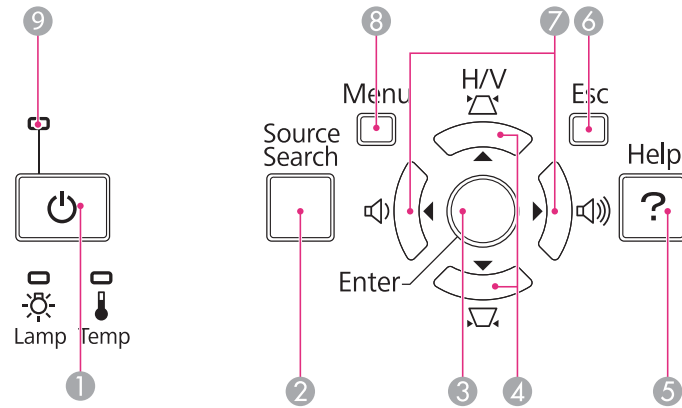

| Name | Function |
|--------------------------|--|
| ① [Power] button | Turns the projector power on or off. ☛ "From Installation to Projection" p.30 |
| ② [Source Search] button | Changes to the next input source that is sending an image. ☛ "Automatically Detect Input Signals and Change the Projected Image (Source Search)" p.31 |
| ③ [Enter] button | <ul style="list-style-type: none"> When the Configuration menu or the Help screen is displayed, it accepts and enters the current selection and moves to the next level. If pressed while projecting analog RGB signals from the Computer port, you can automatically optimize Tracking, Sync., and Position. |
| ④ [H/V] buttons | <ul style="list-style-type: none"> Displays the Keystone screen allowing you to correct Keystone distortion in vertical and horizontal directions. ☛ "Correcting manually" p.37 If pressed when the Configuration menu or the Help screen is displayed, these buttons select menu items and setting values. ☛ "Using the Configuration Menu" p.85 ☛ "Using the Help" p.102 |

| Name | Function |
|-------------------------|---|
| ⑤ [Help] button | Displays and closes the Help screen which shows you how to deal with problems if they occur. ☛ "Using the Help" p.102 |
| ⑥ [Esc] button | <ul style="list-style-type: none"> Stops the current function. If pressed when the Configuration menu is displayed, it moves to the previous menu level. ☛ "Using the Configuration Menu" p.85 |
| ⑦ [Left][Right] buttons | <ul style="list-style-type: none"> Adjusts the speaker volume. [Right] Increases the volume. [Left] Decreases the volume. ☛ "Adjusting the Volume" p.41 Corrects keystone distortion in the horizontal direction when the Keystone screen is displayed. ☛ "H/V-Keystone" p.37 If pressed when the Configuration menu or the Help screen is displayed, these buttons select menu items and setting values. ☛ "Using the Configuration Menu" p.85 ☛ "Using the Help" p.102 |
| ⑧ [Menu] button | Displays and closes the Configuration menu. ☛ "Using the Configuration Menu" p.85 |
| ⑨ Indicators | Indicates the projector's status. ☛ "Reading the Indicators" p.104 |

Remote Control

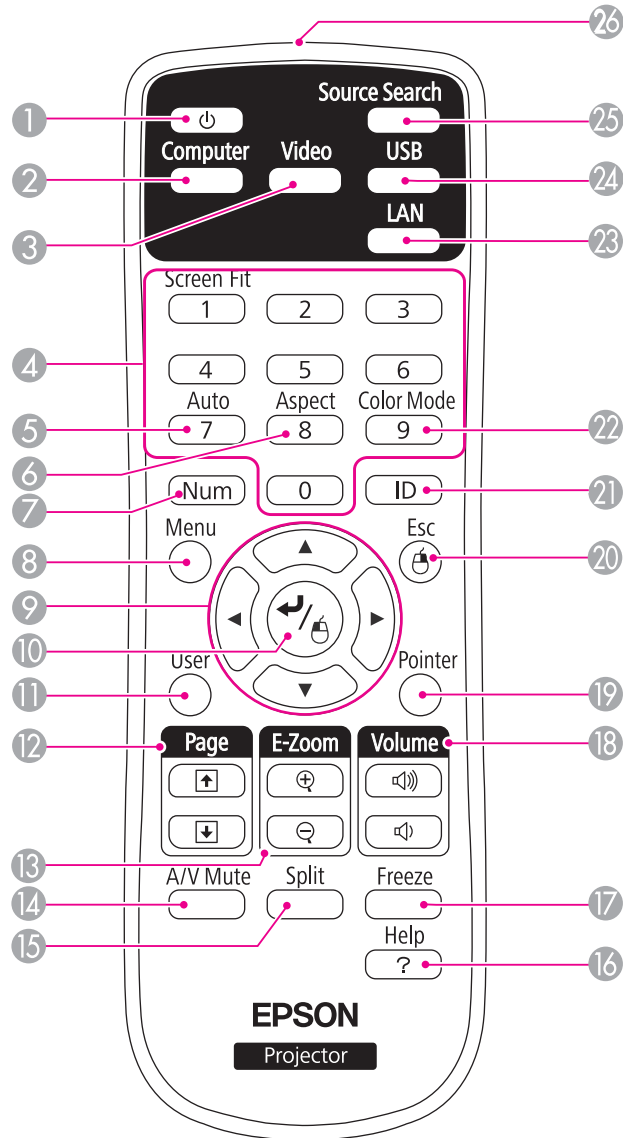

| | Name | Function |
|---|--|---|
| ① | [Power] button | Turns the projector power on or off. ☛ "From Installation to Projection" p.30 |
| ② | [Computer] button | Each time you press the button, the image displayed changes between the Computer1, Computer2, and the DisplayPort ports. |
| ③ | [Video] button | Each time the button is pressed, the image displayed changes between the Video input port and HDMI input port. |
| ④ | Numeric buttons | <ul style="list-style-type: none"> • Enter the Password. ☛ "Setting Password Protect" p.70 • Use this button to enter numbers in Network settings from the Configuration menu. • The screen fit function is unavailable. |
| ⑤ | [Auto] button | If pressed while projecting analog RGB signals from the Computer port, you can automatically optimize Tracking, Sync., and Position. |
| ⑥ | [Aspect] button | Each time the button is pressed, the aspect mode changes. ☛ "Changing the Aspect Ratio of the Projected Image" p.44 |
| ⑦ | [Num] button | Hold down this button and press the numeric buttons to enter passwords and numbers. ☛ "Setting Password Protect" p.70 |
| ⑧ | [Menu] button | Displays and closes the Configuration menu. ☛ "Using the Configuration Menu" p.85 |
| ⑨ | [Left Arrow] [Right Arrow] [Up Arrow] [Down Arrow] buttons | <ul style="list-style-type: none"> • When the Configuration menu or the Help screen is displayed, pressing these buttons selects menu items and setting values. ☛ "Using the Configuration Menu" p.85 • During Wireless Mouse function, the mouse pointer moves in the direction of the button that was pushed. ☛ "Using the Remote Control to Operate the Mouse Pointer (Wireless Mouse)" p.64 |

| Name | Function |
|------------------------------|--|
| ⑩ [↵] button | <ul style="list-style-type: none"> When the Configuration menu or the Help screen is displayed, it accepts and enters the current selection and moves to the next level. <ul style="list-style-type: none"> "Using the Configuration Menu" p.85 Acts as a mouse's left button when using the Wireless Mouse function. <ul style="list-style-type: none"> "Using the Remote Control to Operate the Mouse Pointer (Wireless Mouse)" p.64 |
| ⑪ [User] button | <p>Select any frequently used item from the six available Configuration menu items, and assign it to this button. By pressing the [User] button, the assigned menu item selection/adjustment screen is displayed, allowing you to make one-touch settings/adjustments.</p> <ul style="list-style-type: none"> "Settings Menu" p.90 <p>Power Consumption is assigned as the default setting.</p> |
| ⑫ [Page] buttons [↑][↓] | <p>Changes pages in files such as PowerPoint files when using the following projection methods.</p> <ul style="list-style-type: none"> When using the Wireless Mouse function <ul style="list-style-type: none"> "Using the Remote Control to Operate the Mouse Pointer (Wireless Mouse)" p.64 When using USB Display <ul style="list-style-type: none"> "Projecting with USB Display" p.32 When connecting to a network <p>When projecting images using Slideshow, pressing these buttons displays the previous/next screen.</p> |
| ⑬ [E-Zoom] buttons [⊕][⊖] | <p>Enlarges or reduces the image without changing the projection size.</p> <ul style="list-style-type: none"> "Enlarging Part of the Image (E-Zoom)" p.63 |

| Name | Function |
|------------------------------|---|
| ⑭ [A/V Mute] button | <ul style="list-style-type: none"> Turns the video and audio on or off. <ul style="list-style-type: none"> "Hiding the Image and Sound Temporarily (A/V Mute)" p.61 You can change the Projection mode as follows by pressing the button for about five seconds. <ul style="list-style-type: none"> Front ↔ Front/Ceiling Rear ↔ Rear/Ceiling |
| ⑮ [Split] button | <p>Each time the button is pressed, the image changes between projecting two images simultaneously by splitting the projected screen, or projecting one image as normal.</p> <ul style="list-style-type: none"> "Projecting Two Images Simultaneously (Split Screen)" p.49 |
| ⑯ [Help] button | <p>Displays and closes the Help screen which shows you how to deal with problems if they occur.</p> <ul style="list-style-type: none"> "Using the Help" p.102 |
| ⑰ [Freeze] button | <p>Images are paused or unpaused.</p> <ul style="list-style-type: none"> "Freezing the Image (Freeze)" p.61 |
| ⑱ [Volume] buttons [⏪][⏩] | <p>[⏪] Decreases the volume. [⏩] Increases the volume.</p> <ul style="list-style-type: none"> "Adjusting the Volume" p.41 |
| ⑲ [Pointer] button | <p>Displays the on-screen pointer.</p> <ul style="list-style-type: none"> "Pointer Function (Pointer)" p.62 |
| ⑳ [Esc] button | <ul style="list-style-type: none"> Stops the current function. If pressed when the Configuration menu is displayed, it moves to the previous level. <ul style="list-style-type: none"> "Using the Configuration Menu" p.85 Acts as a mouse's right button when using the Wireless Mouse function. <ul style="list-style-type: none"> "Using the Remote Control to Operate the Mouse Pointer (Wireless Mouse)" p.64 |

| Name | Function |
|---------------------------------------|--|
| ②① [ID] button | Hold down this button and press the numeric buttons to select the ID for the projector you want to operate using the remote control. ☛ "Setting an ID and using the remote control" p.65 |
| ②② [Color Mode] button | Each time the button is pressed, the Color Mode changes. ☛ "Selecting the Projection Quality (Selecting Color Mode)" p.43 |
| ②③ [LAN] button | Switches to the image from the network connected device. |
| ②④ [USB] button | Each time the button is pressed, the image displayed changes between the following sources. <ul style="list-style-type: none"> • USB Display • Images from the device connected to the USB(TypeA) port |
| ②⑤ [Source Search] button | Changes to the next input source that is sending an image. ☛ "Automatically Detect Input Signals and Change the Projected Image (Source Search)" p.31 |
| ②⑥ Remote control light-emitting area | Outputs remote control signals. |

Replacing the remote control batteries

If delays in the responsiveness of the remote control occur or if it does not operate after it has been used for some time, it probably means that the batteries are becoming flat. When this happens, replace them with new batteries. Have two AA size manganese or alkaline batteries ready. You cannot use other batteries except for the AA size manganese or alkaline.

Attention

Make sure you read the following manual before handling the batteries.

☛ [Safety Instructions](#)

1 Remove the battery cover.

While pushing the battery compartment cover catch, lift the cover up.

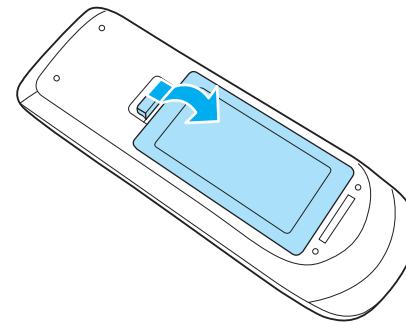

2 Replace the old batteries with new batteries.

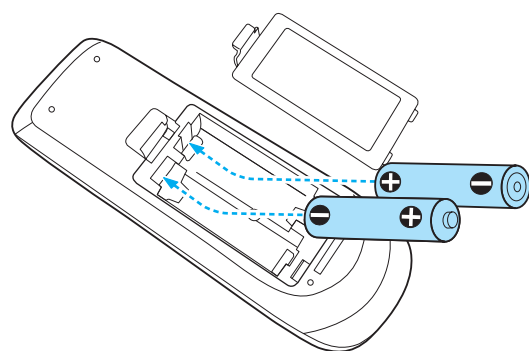

Caution

Check the positions of the (+) and (-) marks inside the battery holder to ensure the batteries are inserted the correct way.
If the batteries are not used correctly, they could explode or leak causing a fire, injury, or damage to the product.

- 3** Replace the battery cover.
Press the battery compartment cover until it clicks into place.

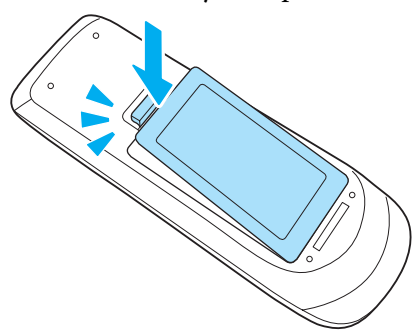

Remote control operating range

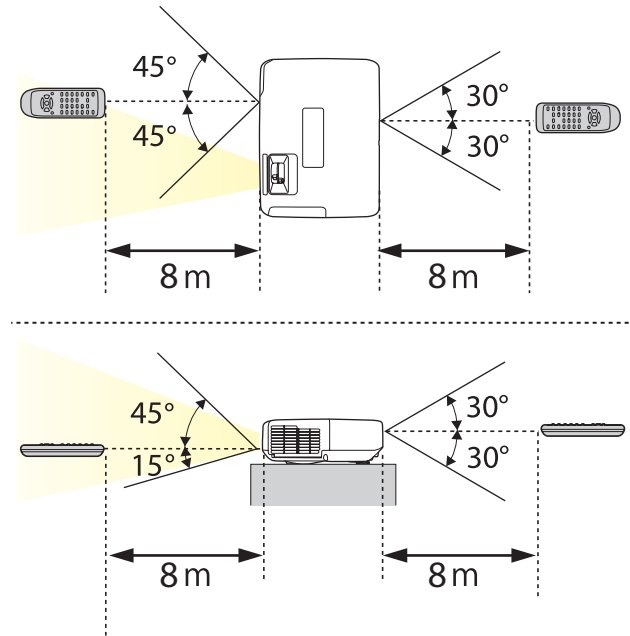



Preparing the Projector

This chapter explains how to install the projector and connect projection sources.

Installation Methods

The projector supports the following four different projection methods. Install the projector according to the conditions of the installation location.

- Project images from in front of the screen. (Front projection)

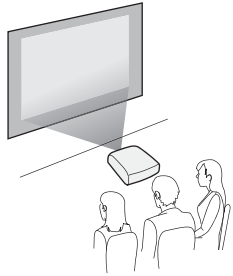

- Project images from behind a translucent screen. (Rear projection)

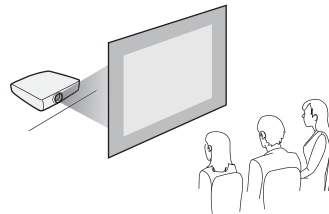

- Suspend the projector from the ceiling and project images from in front of a screen. (Front/Ceiling projection)

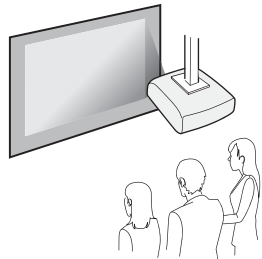

- Suspend the projector from the ceiling and project images from behind a translucent screen. (Rear/Ceiling projection)

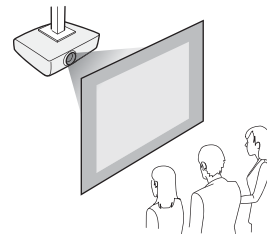

Warning

- A special method of installation is required when suspending the projector from a ceiling (ceiling mount). If it is not installed correctly, it could fall causing an accident and injury.
- If you use adhesives on the Ceiling mount fixing points to prevent the screws from loosening, or if you use things such as lubricants or oils on the projector, the projector case may crack causing it to fall from its ceiling mount. This could cause serious injury to anyone under the ceiling mount and could damage the projector.
When installing or adjusting the ceiling mount, do not use adhesives to prevent the screws from loosening and do not use oils or lubricants and so on.
- Do not cover the projector's air intake vent or air exhaust vent. If either of the vents are covered, the internal temperature could rise and cause a fire.

Attention

Do not use the projector on its side. This may cause malfunctions to occur.



- An optional Ceiling mount is required when suspending the projector from a ceiling.
☛ "Optional Accessories" [p.128](#)
- The default Projection setting is **Front**. You can change from **Front** to **Rear** from the Configuration menu.
☛ **Extended - Projection** [p.91](#)
- You can change the Projection mode as follows by pressing down the [A/V Mute] button on the remote control for about five seconds.
Front ↔ Front/Ceiling
Rear ↔ Rear/Ceiling

Installation methods

Install the projector as follows.

- Install the projector so that it is parallel to the screen.
If the projector is installed at an angle to the screen, keystone distortion occurs in the projected image.

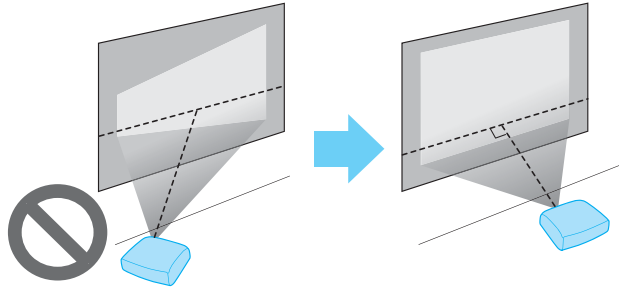

- Place the projector on a level surface.
If the projector is tilted the projected image is also tilted.

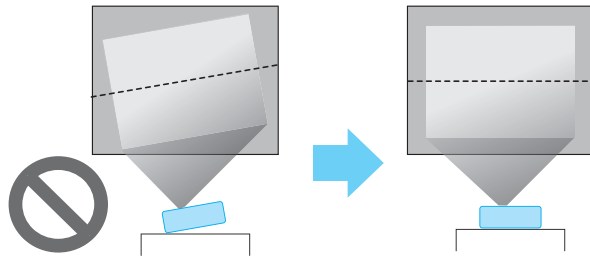

- See the following if you cannot install the projector parallel to the screen.
 - ☛ "Correcting Keystone Distortion" [p.36](#)
- See the following if you cannot install the projector on a level surface.
 - ☛ "Adjusting the Horizontal Tilt" [p.40](#)
 - ☛ "Correcting Keystone Distortion" [p.36](#)

Screen Size and Approximate Projection Distance

Projection size is determined by the distance from the projector to the screen. See the illustrations on the right to select the best position according to the screen size. The illustrations show the approximate shortest distance at maximum zoom. See the following for more information on the projection distance.

☛ "Screen Size and Projection Distance" [p.130](#)



When you correct keystone distortion, the projected image may be reduced.

16:10 Screen Size

For EB-1940W

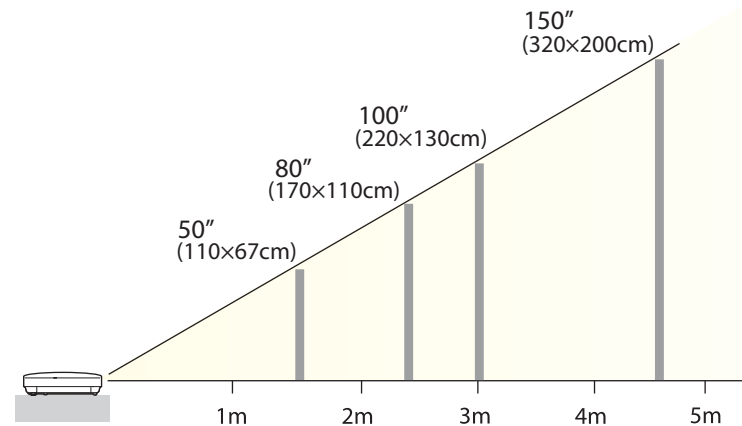

4:3 Screen Size

For EB-1960/EB-1950/EB-1930

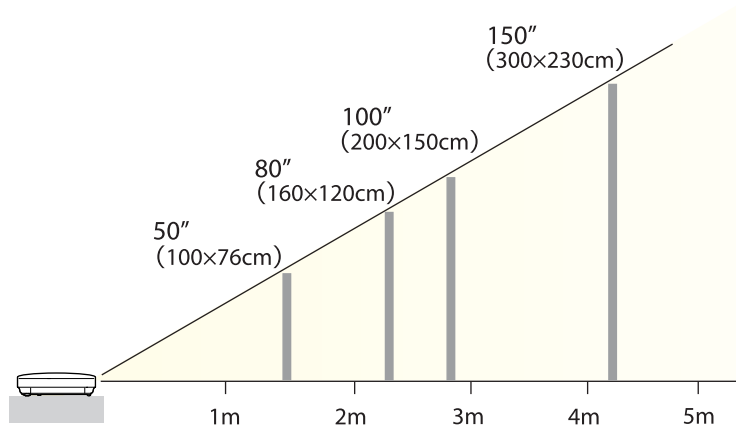

The port name, location, and connector orientation differ depending on the source being connected.

Connecting a Computer

To project images from a computer, connect the computer using one of the following methods.

① **When using the supplied computer cable**

Connect the computer's display output port to the projector's Computer port.

You can output audio from the projector's speaker by connecting the audio output port on the computer to the projector's Audio1 or Audio2 port using a commercially available audio cable.

② **When using a commercially available USB cable**

Connect the computer's USB port to the projector's USB(TypeB) port.

You can send the computer's audio with the projected image.

③ **When using a commercially available HDMI cable**

Connect the computer's HDMI port to the projector's HDMI port.

You can send the computer's audio with the projected image.

④ **When using a commercially available DisplayPort cable**

Connect the computer's DisplayPort to the projector's DisplayPort.

You can send the computer's audio with the projected image.

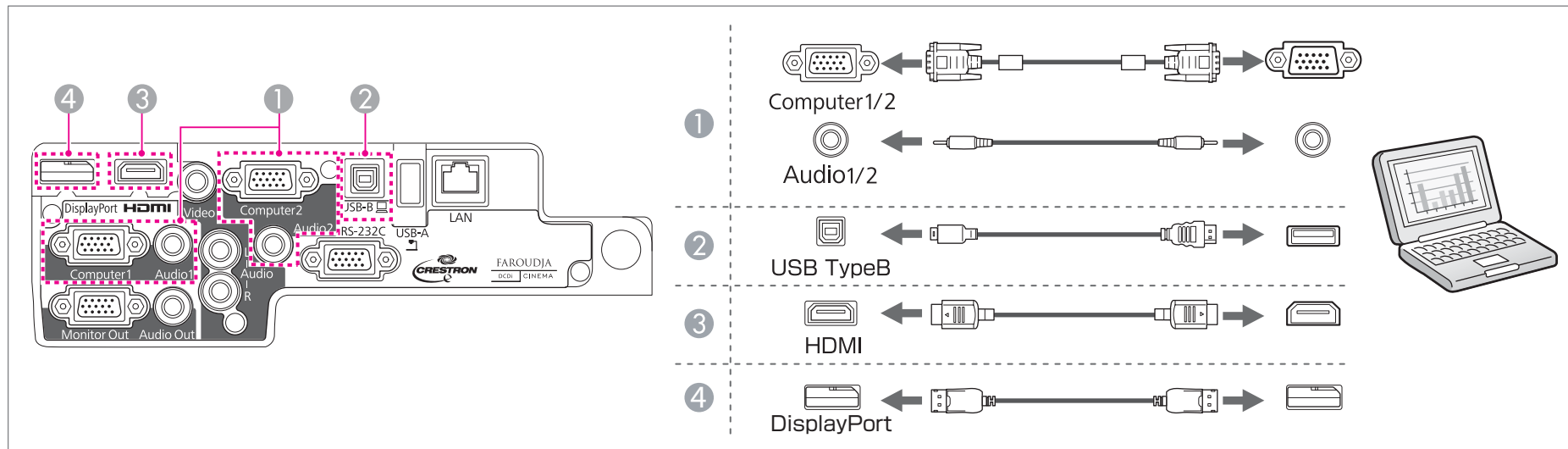

- 

• You can use a USB cable to connect the projector to a computer to project images from the computer. This function is called USB Display.
 "Projecting with USB Display" [p.32](#)
- Some commercially available DisplayPort cables come with a lock. When removing the cable, press the button on the cable's connector section and pull out the cable.

Connecting Image Sources

To project images from DVD players or VHS video and so on, connect to the projector using one of the following methods.

1 When using a commercially available video cable

Connect the video output port on the image source to the projector's Video port.

You can output audio from the projector's speaker by connecting the audio output port on the image source to the projector's Audio-L/R port using a commercially available audio cable.

2 When using the optional component video cable

 "Optional Accessories" [p.128](#)

Connect the component output port on the image source to the projector's Computer input port.

You can output audio from the projector's speaker by connecting the audio output port on the video equipment to the projector's Audio1 or Audio2 port using a commercially available audio cable.

3 When using a commercially available HDMI cable

Connect the HDMI port on the image source to the projector's HDMI port.

You can send the image source's audio with the projected image.

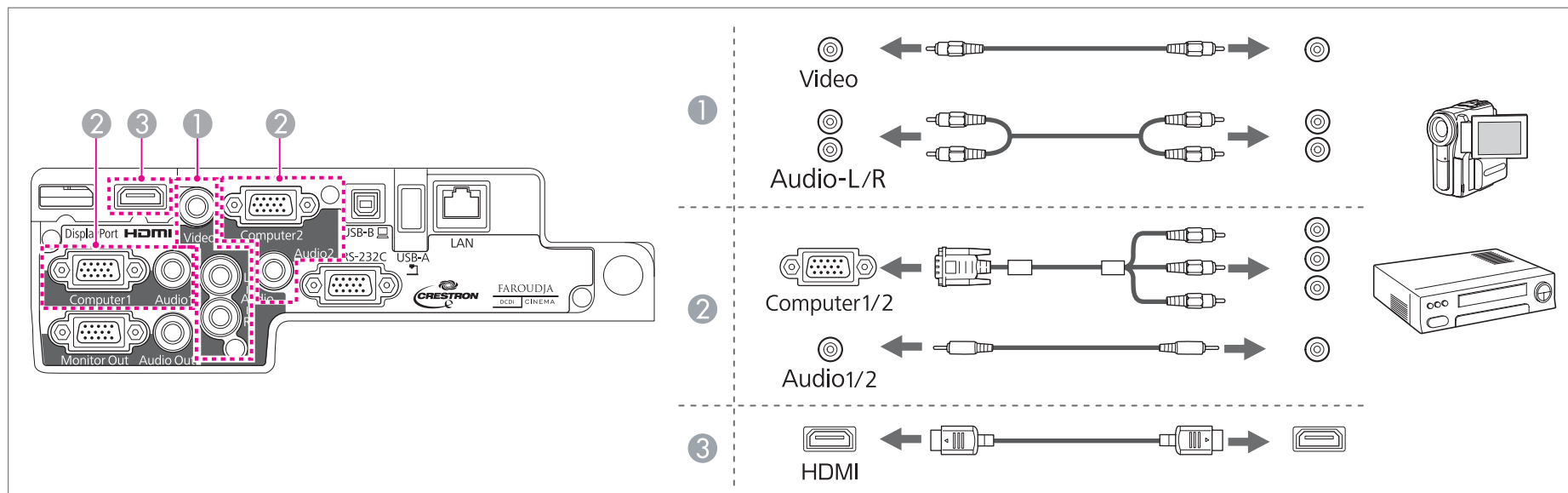

Attention

- If the input source is on when you connect it to the projector, it could cause a malfunction.
- If the orientation or shape of the plug differs, do not try to force it in. The device could be damaged or could malfunction.



- If the source you want to connect to has an unusually shaped port, use the cable supplied with the device or an optional cable to connect to the projector.
- When using a commercially available 2RCA(L/R)/stereo mini-pin audio cable, make sure it is labeled "No resistance".

Connecting USB Devices

You can connect devices such as the optional Document Camera, a USB memory, and USB compatible hard disks and digital cameras.

Using the USB cable supplied with the USB device, connect the USB device to the USB(TypeA) port on the projector.

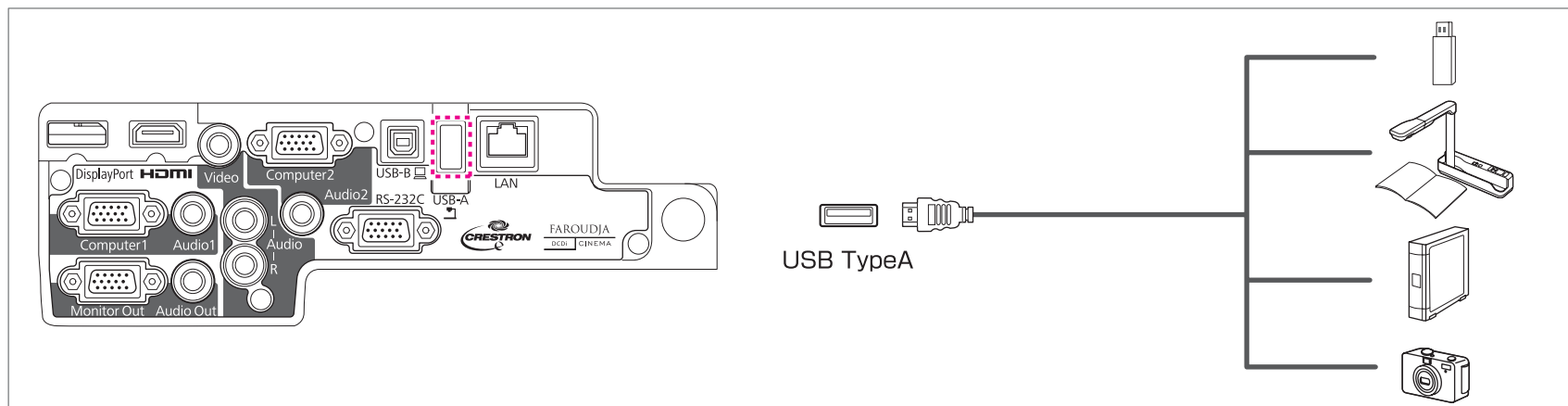

When the USB device is connected, you can project files on the USB memory or digital camera using Slideshow.

☛ "Slideshow examples" [p.53](#)

Attention

- If you use a USB hub, the connection may not operate correctly. Devices such as digital cameras and USB devices should be connected to the projector directly.
- When connecting and using a USB-compatible hard disk, make sure you connect the AC adaptor supplied with the hard disk.
- Connect a digital camera or hard disk to the projector using a USB cable supplied with or specified for use with the device.
- Use a USB cable less than 3 m in length. If the cable exceeds 3 m, Slideshow may not function correctly.

Removing USB devices

After finishing projecting, remove USB devices from the projector. For devices such as digital cameras or hard disks, turn off the device and then remove it from the projector.

Connecting External Equipment

You can output images and audio by connecting an external monitor or speaker.

① **When outputting images to an external monitor**

Connect the external monitor to the projector's Monitor Out port using the cable supplied with the external monitor.

② **When outputting audio to an external speaker**

Connect the external speaker to the projector's Audio Out port using a commercially available audio cable.

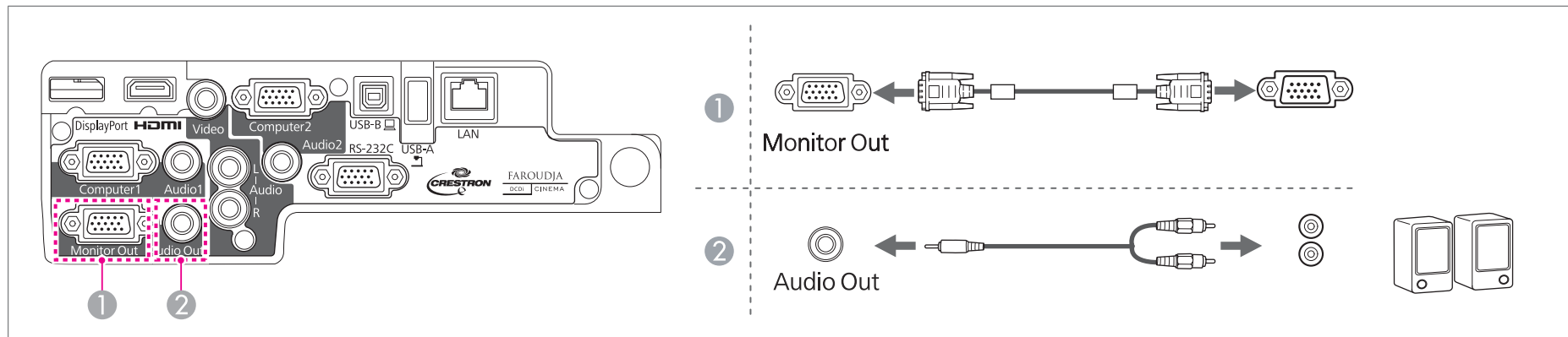

• If you set **Standby Mode** to **Communication On**, you can output images to an external monitor even if the projector is in standby mode.

☛ **Extended - Standby Mode** p.91

- Only analog RGB signals from the Computer1 port can be output to an external monitor. You cannot output signals input from other ports or component video signals.
- Setting gauges for functions such as Keystone, Configuration Menu, or Help screens are not output to the external monitor.
- When the audio cable jack is inserted into the Audio Out port, audio stops being output from the projector's built-in speakers and switches to external output.

Connecting a LAN Cable

Connect a LAN port on network hubs or other equipment to the projector's LAN port with a commercially available 100BASE-TX or 10BASE-T LAN cable.

By connecting a computer to the projector over a network, you can project images and check the status of the projector.

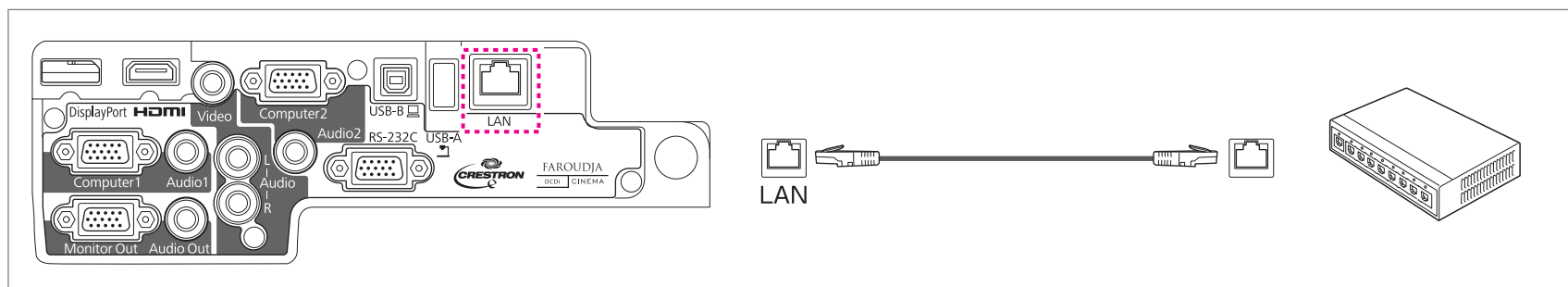

To prevent malfunctions, use a category 5 or higher shielded LAN cable.



Basic Usage

This chapter explains how to project and adjust images.

From Installation to Projection

This section explains the procedure for connecting the projector to a computer with the computer cable and projecting images.

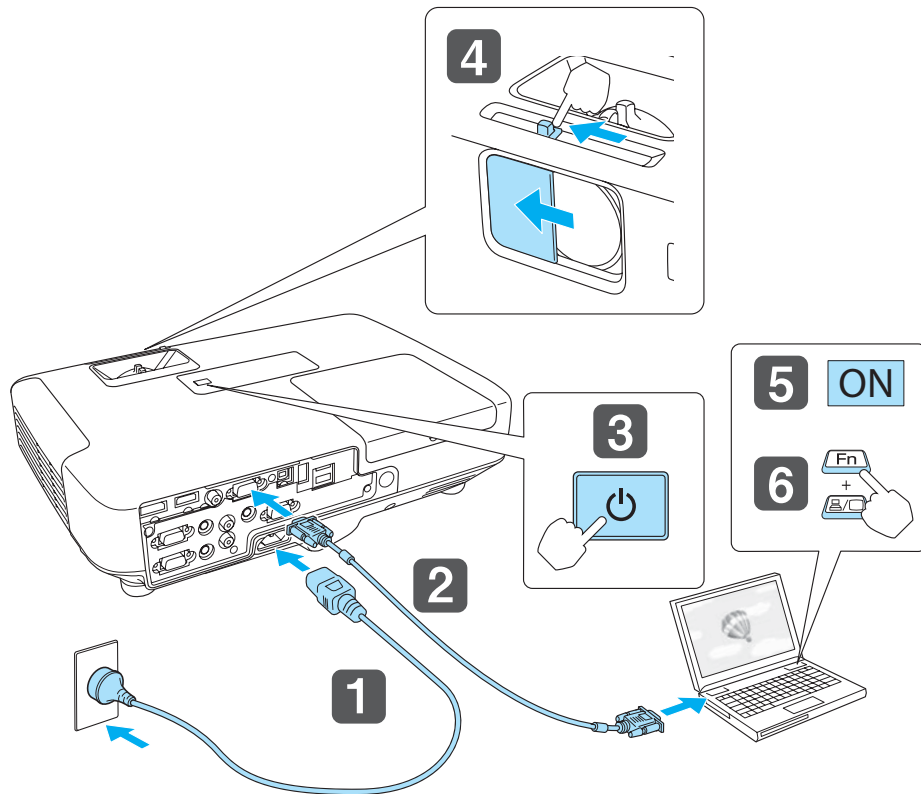

- 1** Connect the projector to an electrical outlet with the power cord.
- 2** Connect the projector to the computer with the computer cable.
- 3** Turn on the projector.
- 4** Open the A/V mute slide.

5 Turn on your computer.

6 Change the computer's screen output.

When using a laptop computer, you need to change the screen output from the computer.

Hold down the Fn key (function key), and press the key.



- The method for changing differs depending on the computer being used. See the documentation supplied with the computer.
- When turning off the projector, press the [⏻] button twice.

If the image is not projected, you can change the projected image using one of the following methods.

- Press the [Source Search] button on the control panel or the remote control.
 - ☛ "Automatically Detect Input Signals and Change the Projected Image (Source Search)" [p.31](#)
- Press the button for the target port on the remote control.
 - ☛ "Switching to the Target Image by Remote Control" [p.32](#)



After projecting the image, adjust the image if necessary.

- ☛ "Correcting Keystone Distortion" [p.36](#)
- ☛ "Correcting the Focus" [p.41](#)

Automatically Detect Input Signals and Change the Projected Image (Source Search)

Press the [Source Search] button to project images from the port currently receiving an image.

Using the remote control

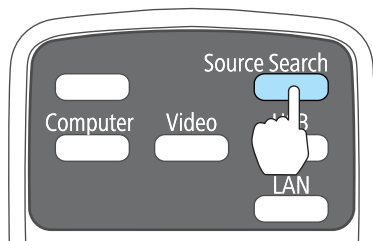

Using the control panel

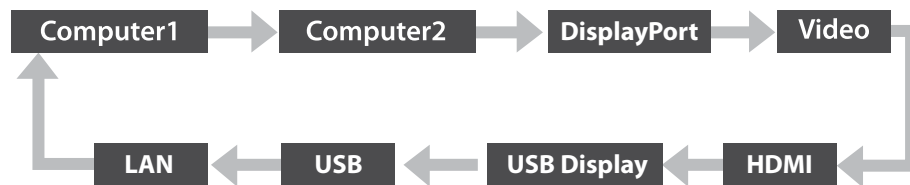
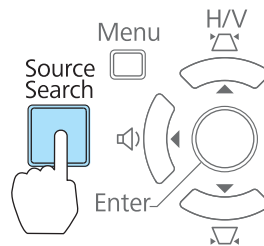

When two or more image sources are connected, press the [Source Search] button until the target image is projected.

When your video equipment is connected, start playback before beginning this operation.



The following screen is displayed while no image signals are input.

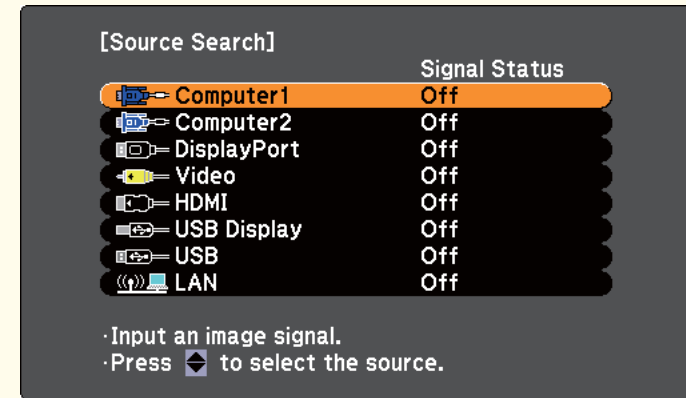

[] :Select [] :Enter [Esc] :Exit

Switching to the Target Image by Remote Control

You can change directly to the target image by pressing the following buttons on the remote control.

Remote control

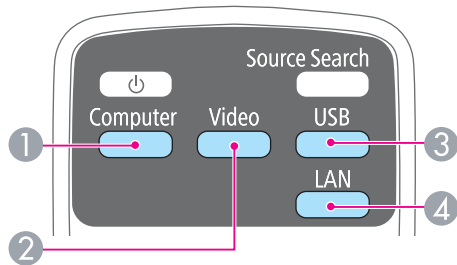

- ① Each time the button is pressed, it cycles through the images being input from the following sources.
 - Computer1 port
 - Computer2 port
 - DisplayPort
- ② Each time the button is pressed, it cycles through the images being input from the following sources.
 - Video port
 - HDMI port
- ③ Each time the button is pressed, it cycles through the images being input from the following sources.
 - USB Display
 - Images from the device connected to the USB(TypeA) port
- ④ Switches to the image from the network connected device.

Projecting with USB Display

You can use a USB cable to connect the projector to a computer to project images from the computer.

You can project images and send audio with one USB cable.

System requirements

For Windows

| | | |
|-------------------------|--|---|
| OS | Windows 2000*1 | |
| | Windows XP | Professional 32 bit Home Edition 32 bit Tablet PC Edition 32 bit |
| | Windows Vista | Ultimate 32 bit Enterprise 32 bit Business 32 bit Home Premium 32 bit Home Basic 32 bit |
| | Windows 7 | Ultimate 32/64 bit Enterprise 32/64 bit Professional 32/64 bit Home Premium 32/64 bit Home Basic 32 bit Starter 32 bit |
| CPU | Mobile Pentium III 1.2 GHz or faster Recommended: Pentium M 1.6 GHz or faster | |
| Amount of Memory | 256 MB or more Recommended: 512 MB or more | |
| Hard Disk Space | 20 MB or more | |

| | |
|----------------|--|
| Display | Resolution of no less than 640x480 and no higher than 1600x1200. Display color in 16-bit color or greater |
|----------------|--|

*1 Service Pack 4 only

For Mac OS X

| | |
|-------------------------|--|
| OS | Mac OS X 10.5.x 32 bit Mac OS X 10.6.x 32/64 bit Mac OS X 10.7.x 32/64 bit |
| CPU | Power PC G4 1GHz or faster Recommended: Core Duo 1.83GHz or faster |
| Amount of Memory | 512 MB or more |
| Hard Disk Space | 20 MB or more |
| Display | Resolution of no less than 640x480 and no higher than 1680x1200. Display color in 16-bit color or greater |

Connecting for the first time

The first time you connect the projector and the computer using the USB cable, the driver needs to be installed. The procedure is different for Windows and Mac OS X.



- You do not need to install the driver the next time you connect.
- When inputting images from multiple sources, change the input source to USB Display.
- Use a commercially available USB cable.
- If you use a USB hub, the connection may not operate correctly. Connect the USB cable directly to the projector.

For Windows

- 1** Connect the computer's USB port to the projector's USB(TypeB) port using a USB cable.



For Windows 2000 or Windows XP, a message asking you if you want to restart your computer may be displayed. Select **No**.

For Windows 2000

Double-click **Computer**, **EPSON PJ_UD**, and then **EMP_UDSE.EXE**.

For Windows XP

Driver installation starts automatically.

For Windows Vista/Windows 7

When the dialog box is displayed, click **Run EMP_UDSE.exe**.

- 2** When the License Agreement screen is displayed, click **Agree**.

- 3** Computer images are projected.
It may take a while before computer images are projected. Until computer images are projected, leave the equipment as it is and do not disconnect the USB cable or turn off the power to the projector.
- 4** Disconnect the USB cable when you finish projection.
When disconnecting the USB cable, there is no need to use **Safely Remove Hardware**.



- If it is not installed automatically, double-click **My Computer - EPSON_PJ_UD - EMP_UDSE.EXE** on your computer.
- If nothing is projected for some reason, click **All Programs - EPSON Projector - Epson USB Display - Epson USB Display Vx.xx** on your computer.
- When using a computer running Windows 2000 under user authority, a Windows error message is displayed and you may not be able to use the software. In this case, try updating Windows to the latest version, restart, and then try to connect again.
For more details, contact your local dealer or the nearest address provided in the following document.
[Epson Projector Contact List](#)

For Mac OS X

- 1** Connect the computer's USB port to the projector's USB(TypeB) port using a USB cable.
The Setup folder of USB Display is displayed in the Finder.
- 2** Double-click the **USB Display Installer** icon.
- 3** Follow the on-screen instructions to install.

- 4** When the License Agreement screen is displayed, click **Agree**.
Enter the administrator authority password and start the installation.
When the installation is complete, the USB Display icon is displayed in the Dock and menu bar.
- 5** Computer images are projected.
It may take a while before computer images are projected. Until computer images are projected, leave the equipment as it is and do not disconnect the USB cable or turn off the power to the projector.
- 6** When you finish projection, select **Disconnect** from the **USB Display** icon menu on the menu bar or Dock, and then remove the USB cable.



- If the USB Display setup folder is not displayed automatically in the Finder, double-click **EPSON PJ_UD - USB Display Installer** on your computer.
- If nothing is projected for some reason, click the **USB Display** icon in the Dock.
- If there is no **USB Display** icon in the Dock, double-click **USB Display** from the Applications folder.
- If you select **Exit** from the **USB Display** icon menu on the Dock, USB Display does not start automatically when you connect the USB cable.

Uninstalling

For Windows 2000

- 1** Click **Start**, select **Settings**, and then click **Control Panel**.
- 2** Double-click **Add/Remove Programs**.
- 3** Click **Change or Remove Programs**.
- 4** Select **Epson USB Display** and click **Change/Remove**.

For Windows XP

- 1 Click **Start**, and then click **Control Panel**.
- 2 Double-click **Add or Remove Programs**.
- 3 Select **Epson USB Display** and click **Remove**.

For Windows Vista/Windows 7

- 1 Click **Start**, and then click **Control Panel**.
- 2 Click **Uninstall a program** under **Programs**.
- 3 Select **Epson USB Display** and click **Uninstall**.

For Mac OS X

- 1 Open the **Applications** folder, double-click **USB Display**, and then double-click **Tool**.
- 2 Run **USB Display Uninstaller**.

Correcting Keystone Distortion

You can correct keystone distortion using one of the following methods.

- Correcting automatically (Auto V-Keystone)
- Correcting manually (H-Keystone Adjuster)
Manually corrects horizontal keystone distortion using the horizontal keystone adjuster.

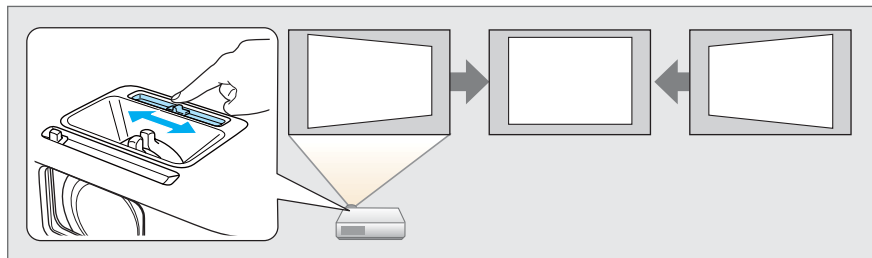

- Correcting manually (H/V-Keystone)
Manually correct distortion in the horizontal and vertical directions independently.

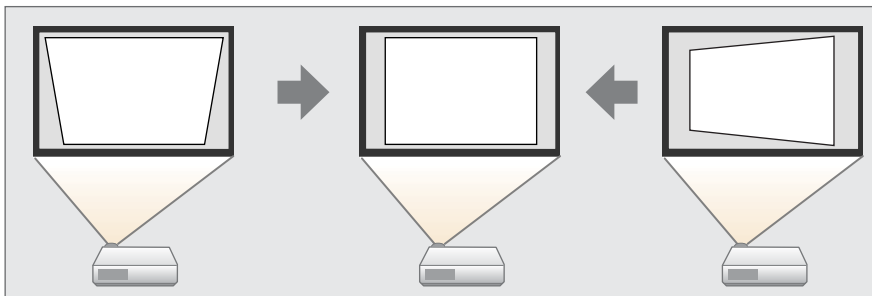

- Correcting manually (Quick Corner)
Manually correct the four corners independently.

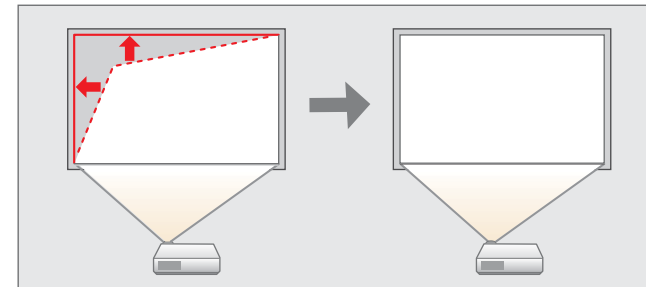

When you correct keystone distortion, the projected image may be reduced.

Correcting automatically

Auto V-Keystone

When the projector detects any movement, for example when it is moved or tilted, it automatically corrects vertical keystone distortion. This function is called Auto V-Keystone.

When the projector is moved, it displays a screen for adjustment and then automatically corrects the projected image.

You can use Auto V-Keystone to correct the projected image under the following conditions.

Correction angle: approx. 30° up and down



- Auto V-Keystone works only when **Projection** is set to **Front** from the Configuration menu.
 - ☛ **Extended - Projection** p.91
- If you do not want to enable Auto V-Keystone, set **Auto V-Keystone** to **Off**.
 - ☛ **Settings - Keystone - H/V-Keystone - Auto V-Keystone** p.90



- When using horizontal keystone adjuster, set **H-Keystone Adjuster** to **On**.
 - ☛ **Settings - Keystone - H/V-Keystone - H-Keystone Adjuster** p.90
- You can also correct keystone distortion in the horizontal direction using H/V-Keystone.

Correcting manually

You can manually correct keystone distortion.

You can use H/V-Keystone to correct the projected image under the following conditions.

Correction angle: approx 30° right and left/approx. 30° up and down

H-Keystone Adjuster

Move the horizontal keystone adjuster to the right or left to perform horizontal keystone correction.

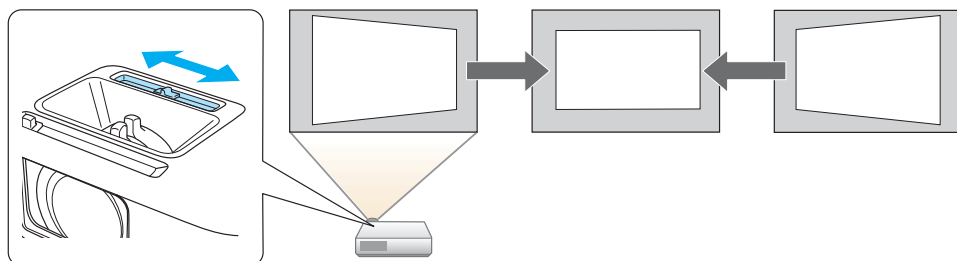

H/V-Keystone

Manually correct distortion in the horizontal and vertical directions independently.

- 1 Press the [▽] or [△] button on the control panel during projection to display the Keystone screen.

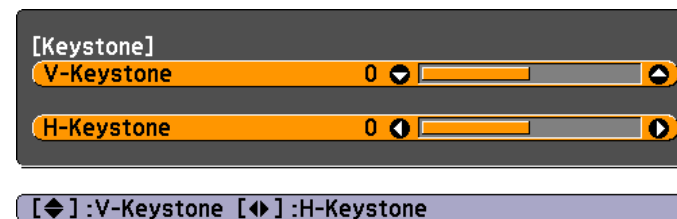

- 2 Press the following buttons to correct keystone distortion. Press the [▽] or [△] button to correct vertical distortion.

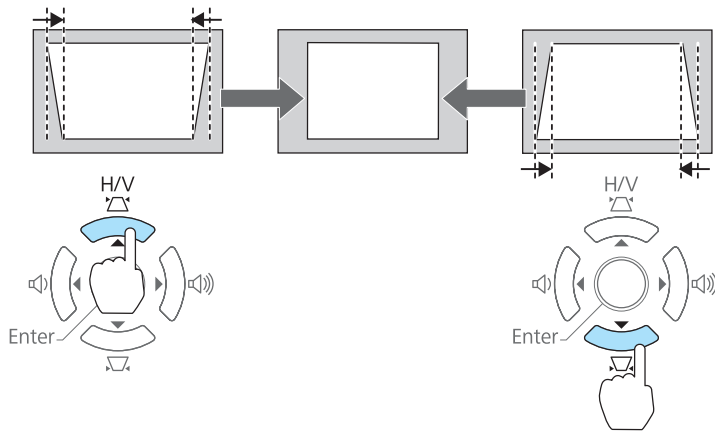

Press the [◀] or [▶] button to correct horizontal distortion.

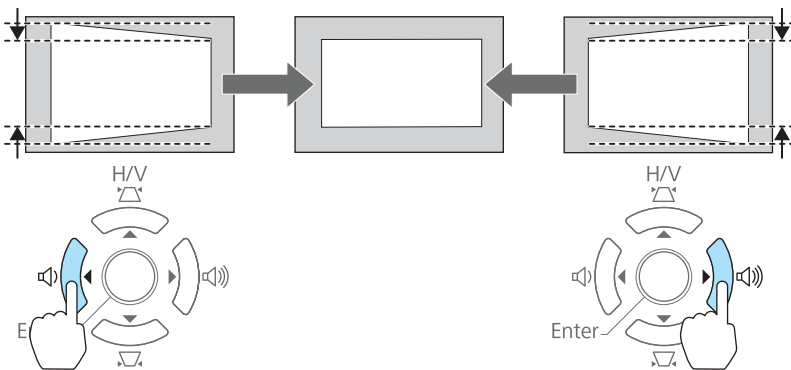

You can also set H/V-Keystone from the Configuration menu.

➡ **Settings - Keystone - H/V-Keystone** p.90

Quick Corner

This allows you to manually correct each of the four corners of the projected image separately.

1 Press the [Menu] button while projecting.

➡ "Using the Configuration Menu" p.85

Using the remote control

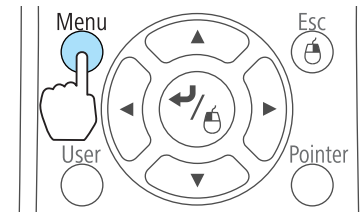

Using the control panel

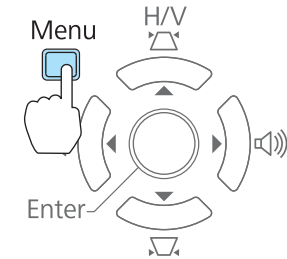

2 Select **Keystone** from **Settings**.

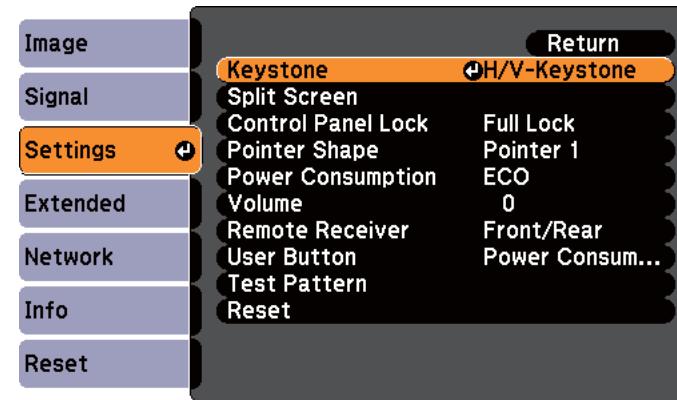

[Esc]:Return [◆]:Select [⏏]:Enter [Menu]:Exit

3 Select **Quick Corner**, and then press the [↶] button.

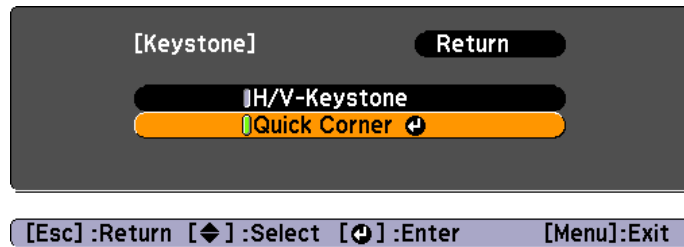

- 4** Using the [↶], [↷], [↵], and [↶] buttons on the remote control, or the [↶], [↷], [↵], and [↶] buttons on the control panel, select the corner to correct, and then press the [↵] button.

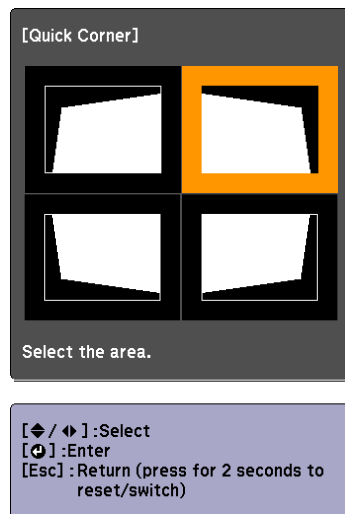

- 5** Using the [↶], [↷], [↵], and [↶] buttons on the remote control, or the [↶], [↷], [↵], and [↶] buttons on the control panel, correct the position of the corner.

When you press the [↵] button, the screen shown in step 4 that allows you to select the area to be corrected is displayed.

If the message "Cannot adjust any further." is displayed while adjusting, you cannot adjust the shape any further in the direction indicated by the gray triangle.

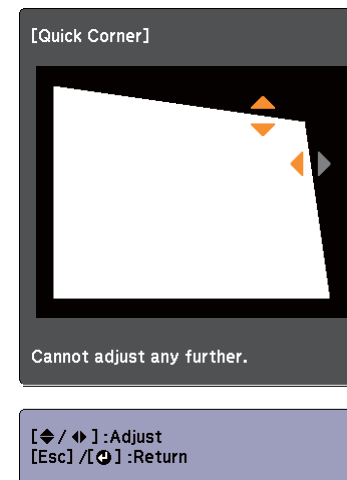

- 6** Repeat procedures 4 and 5 as needed to adjust any remaining corners.
- 7** When you are done, press the [Esc] button to exit the correction menu.

Because **Keystone** was changed to **Quick Corner**, the corner selection screen shown in step 4 is displayed the next time you press the [↶] or [↷] button on the control panel. Change **Keystone** to **H/V-Keystone** if you want to perform horizontal and vertical correction using the [↶] or [↷] button on the control panel.



If the [Esc] button is held down for about two seconds while the corner selection screen from step 4 is displayed, the following screen is displayed.

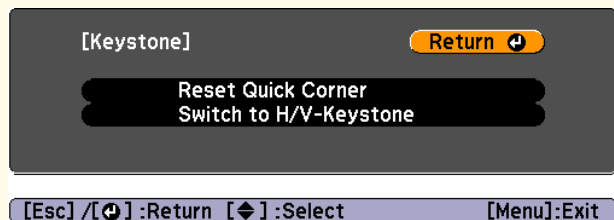

Reset Quick Corner: Resets the result of Quick Corner corrections.
Switch to H/V-Keystone: Switches the correction method to H/V-Keystone.

☞ "Settings Menu" p.90

Adjusting the Image Position

Press the foot adjust lever to extend and retract the front adjustable foot. You can adjust the position of the image by tilting the projector up to 16 degrees.

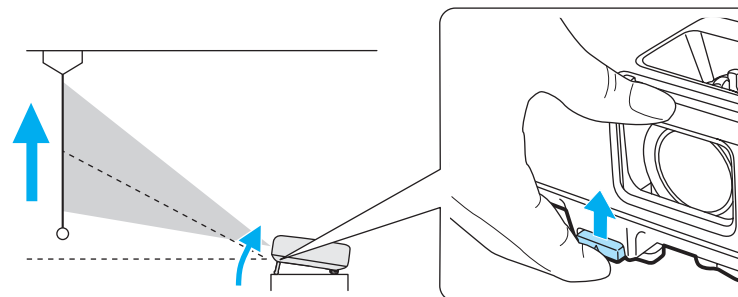

The larger the angle of tilt, the harder it becomes to focus. Install the projector so that it only needs to be tilted at a small angle.

Adjusting the Image Size

Turn the zoom ring to adjust the size of the projected image.

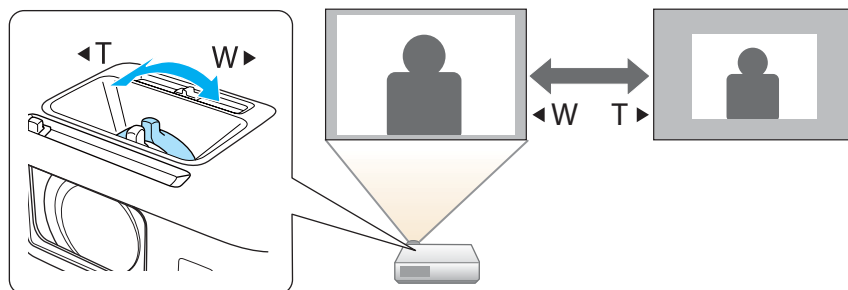

Adjusting the Horizontal Tilt

Extend and retract the rear feet to adjust the projector's horizontal tilt.

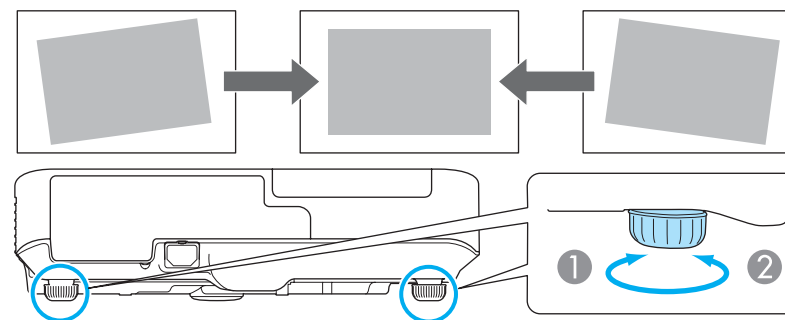

- ① Extend the rear foot.
- ② Retract the rear foot.

Correcting the Focus

You can correct the focus using the focus ring.

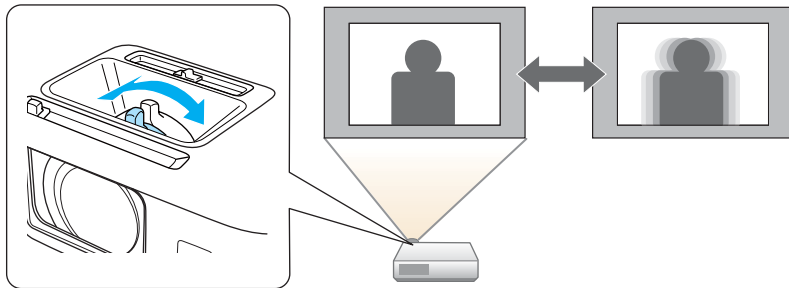

Adjusting the Volume

You can adjust the volume using one of the following methods.

- Press the [Volume] button on the control panel or the remote control to adjust the volume.
 - [◀] Decreases the volume.
 - [▶] Increases the volume.

Using the remote control

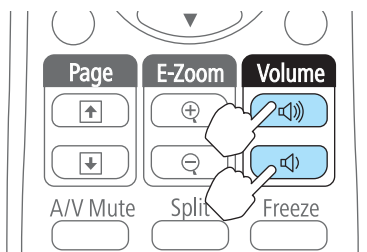

Using the control panel

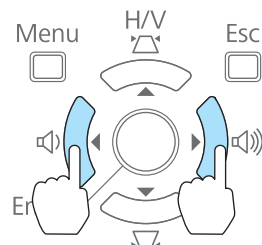

- Adjust the volume from the Configuration menu.
 - ☛ Settings - Volume [p.90](#)

Caution

Do not start at high volume. A sudden excessive volume may cause loss of hearing. Always lower the volume before powering off, so that you can power on and then gradually increase the volume.

Adjusting the Image

Hue, Saturation, and Brightness Adjustment

The Hue, Saturation, and Brightness for each of the R (red), G (green), B (blue), C (cyan), M (magenta) and Y (yellow) color components can be adjusted.

Make settings from the configuration menu.

- ☛ Image - Advanced - RGBCMY [p.87](#)

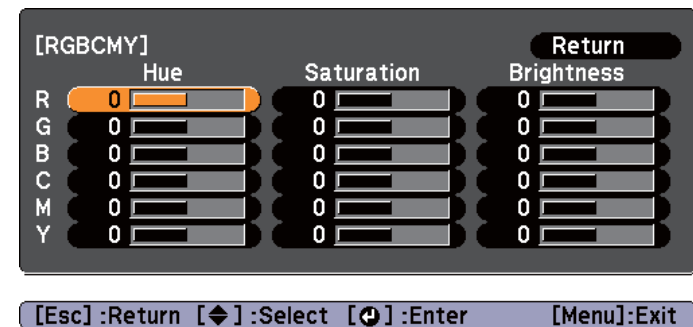

| | |
|------------|--|
| Hue | Adjusts the overall hue of the image, bluish – greenish – reddish. |
| Saturation | Adjusts the overall vividness of the image. |

| | |
|------------|--|
| Brightness | Adjusts the overall color brightness of the image. |
|------------|--|

 Medical images may not be reproduced correctly according to your settings and screen specifications.

Gamma Adjustment

Adjusts differences in the coloring for the projected image that occurs depending on the connected device.

Make settings from the configuration menu.

 **Image - Advanced - Gamma** p.87

Select and adjust the correction value

 **Image - Advanced - Gamma** p.87

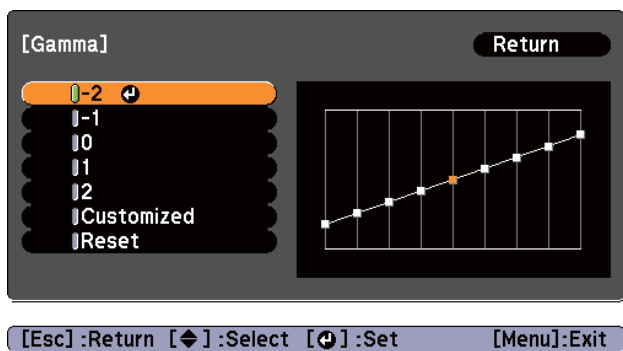

When a smaller value is selected, the dark areas of images become brighter, but the color saturation for lighter areas may become weaker. When a larger value is selected, you can reduce the overall brightness of the image to make the image sharper.

If you select **DICOM SIM** from **Color Mode** on the **Image** menu, select the adjustment value according to the projection size.

- If the projection size is 120 inches or less, select a large value.
- If the projection size is 120 inches or more, select a small value.

Adjust while viewing the image

 **Image - Advanced - Gamma - Customized - Adjust it from the image** p.87

Move the cursor on the projected image to the part where you want to change the brightness, and adjust the value.

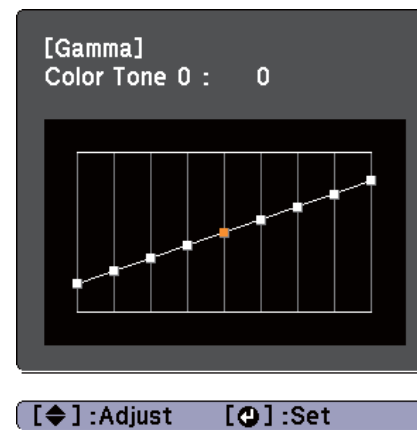
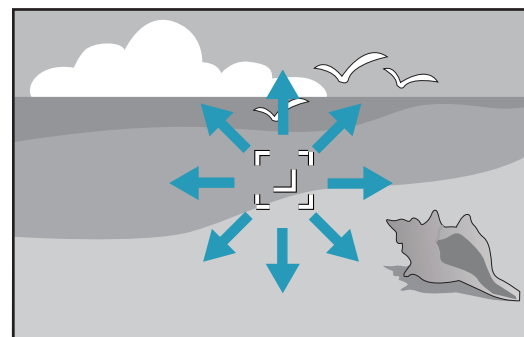

Adjust using the gamma adjustment graph

Image - Advanced - Gamma - Customized - Adjust it from the graph
[p.87](#)

Adjust while looking at the gamma adjustment graph.

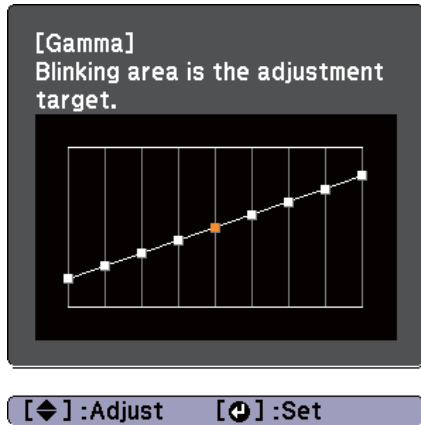

Selecting the Projection Quality (Selecting Color Mode)

You can easily obtain the optimum image quality simply by selecting the setting that best corresponds to your surroundings when projecting. The brightness of the image varies depending on the mode selected.

| Mode | Application |
|---------------------|---|
| Dynamic | Ideal for use in a bright room. This is the brightest mode, and reproduces shadow tones well. |
| Presentation | Ideal for making presentations using color materials in a bright room. |
| Theatre | Ideal for watching films in a dark room. Gives images a natural tone. |

| Mode | Application |
|--------------------|---|
| Photo*1 | Ideal for projecting still pictures, such as photos, in a bright room. The images are vivid and brought into contrast. |
| Sports*2 | Ideal for watching TV programmes in a bright room. The images are vivid and brought to life. |
| sRGB | Ideal for images that conform to the sRGB color standard. |
| Blackboard | Even if you are projecting onto a blackboard (greenboard), this setting gives your images a natural tint, just like when projecting onto a screen. |
| Whiteboard | Ideal for making presentations using a whiteboard. |
| DICOM SIM*1 | Ideal for projecting X-ray photographs and other medical images. This produces images with clear shadows. The projector is not a medical device and cannot be used for medical diagnosis. |

*1 This selection is only available when the input signal is RGB or when the source is USB Display, USB, or LAN.

*2 This selection is only available when the input signal is component video, or when the source is Video.

Each time you press the [Color Mode] button, the Color Mode name is displayed on the screen and the Color Mode changes.

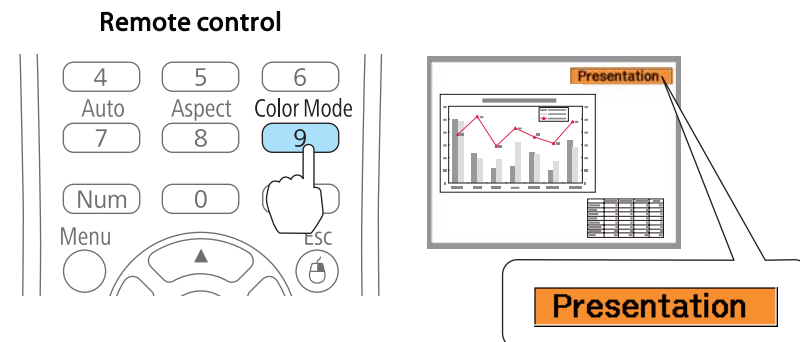



You can set Color Mode from the Configuration menu.

☛ Image - Color Mode [p.87](#)

Setting Auto Iris

By automatically setting the luminance according to the brightness of the displayed image, it lets you enjoy deep and rich images.

1 Press the [Menu] button.

☛ "Using the Configuration Menu" [p.85](#)

Using the remote control

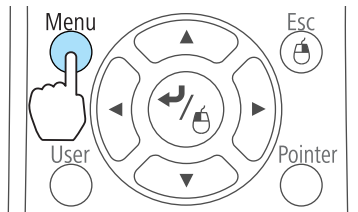

Using the control panel

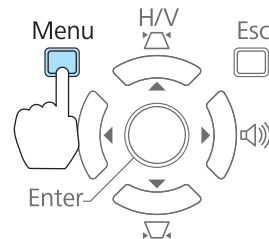

2 Select **Auto Iris** from **Image**.

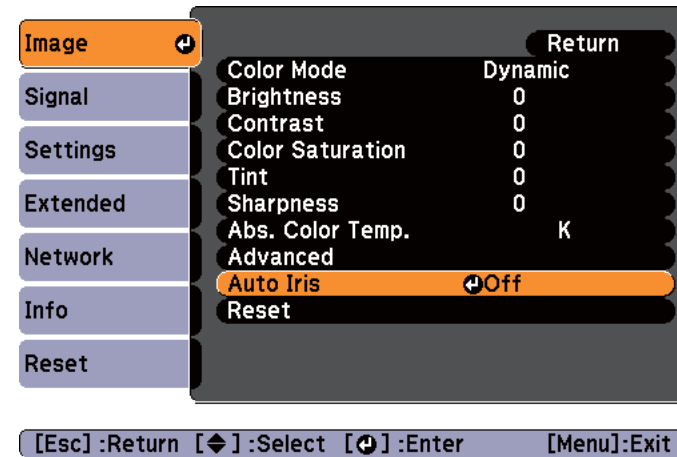

3 Select **On**.

The setting is stored for each Color Mode.

4 Press the [Menu] button to finish making settings.



Auto Iris can only be set when the **Color Mode** is **Dynamic** or **Theatre**.

Changing the Aspect Ratio of the Projected Image

You can change the Aspect Ratio of the projected image to suit the type, the ratio of height and width, and the resolution of the input signals.

Available aspect modes vary depending on the image signal currently being projected.

Changing methods

Each time you press the [Aspect] button on the remote control, the aspect mode name is displayed on the screen and the aspect ratio changes.

Remote control

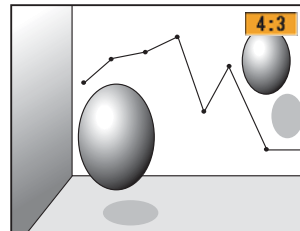
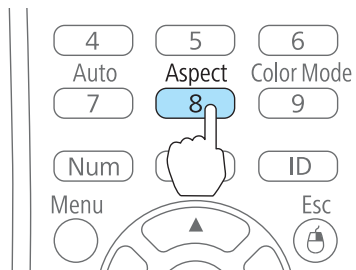

You can set the aspect ratio from the Configuration menu.

🖱️ **Signal - Aspect** [p.88](#)

Changing the aspect mode

Projecting images from video equipment or from the HDMI or DisplayPort ports (for EB-1940W)

Each time the [Aspect] button is pressed, the aspect mode changes in the order **Normal or Auto**, **16:9**, **Full**, **Zoom**, and **Native**.

Example: 1080p signal input (resolution: 1920x1080, aspect ratio: 16:9)

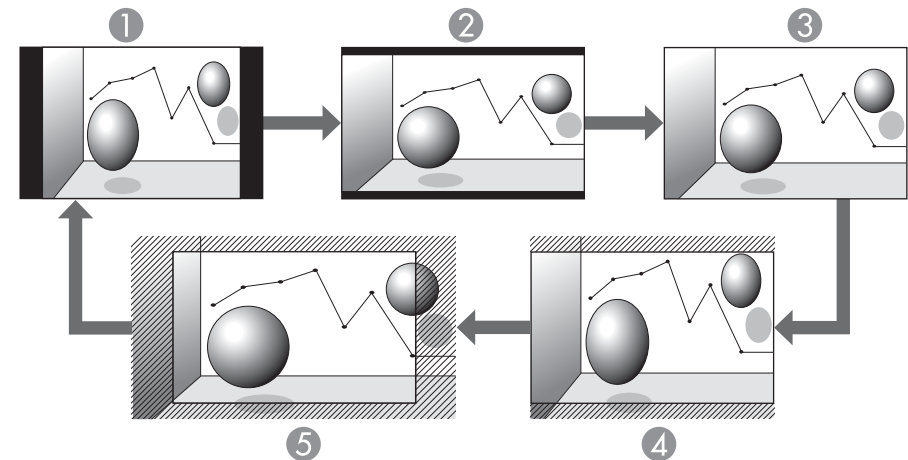

- ① Normal or Auto
- ② 16:9
- ③ Full
- ④ Zoom
- ⑤ Native

Projecting images from video equipment (for EB-1960/EB-1950/EB-1930)

Each time the [Aspect] button is pressed, the aspect mode changes in the order **4:3** and **16:9**.

When inputting a 720p/1080i signal and the aspect mode is set to **4:3**, a 4:3 zoom is applied (the right and left sides of the image are cut off).

Example: 720p signal input (resolution: 1280x720, aspect ratio: 16:9)

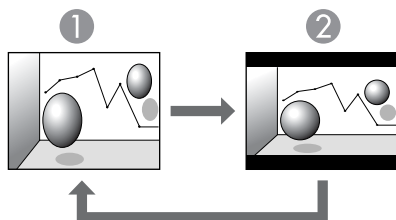

- ① 4:3
- ② 16:9

Projecting images from the HDMI or DisplayPort ports (for EB-1960/EB-1950/EB-1930)

Each time the Aspect button is pressed, the aspect mode changes in the order **Normal** or **Auto**, **4:3**, and **16:9**.

Example: 1080p signal input (resolution: 1920x1080, aspect ratio: 16:9)

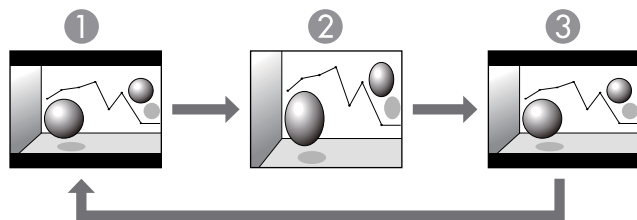

- ① Normal or Auto
- ② 4:3
- ③ 16:9

Projecting images from a computer

The following shows projection examples for each aspect mode.

For EB-1940W

| Aspect Mode | Input Signal | |
|---------------|-------------------|----------------------|
| | XGA 1024X768(4:3) | WXGA 1280X800(16:10) |
| Normal | | |
| 16:9 | | |
| Full | | |
| Zoom | | |
| Native | | |

For EB-1960/EB-1950/EB-1930

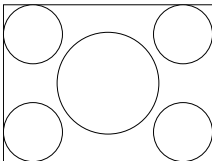
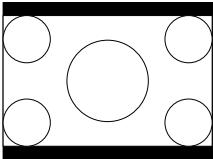
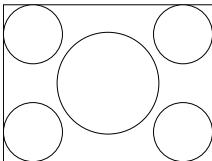
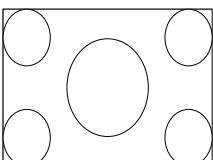
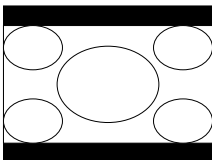
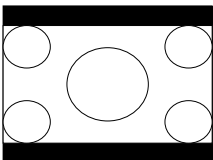
| Aspect Mode | Input Signal | |
|-------------|---|---|
| | XGA 1024X768(4:3) | WXGA 1280X800(16:10) |
| Normal |  |  |
| 4:3 |  |  |
| 16:9 |  |  |



If parts of the image are missing, set the **Resolution** setting to **Wide** or **Normal** from the Configuration menu, according to the size of the computer panel.

☛ **Signal - Resolution** [p.88](#)



Useful Functions

This chapter explains useful tips for giving presentations, and the Security functions.

Projecting Two Images Simultaneously (Split Screen)

You can simultaneously project images from two sources on the right and left of the screen.

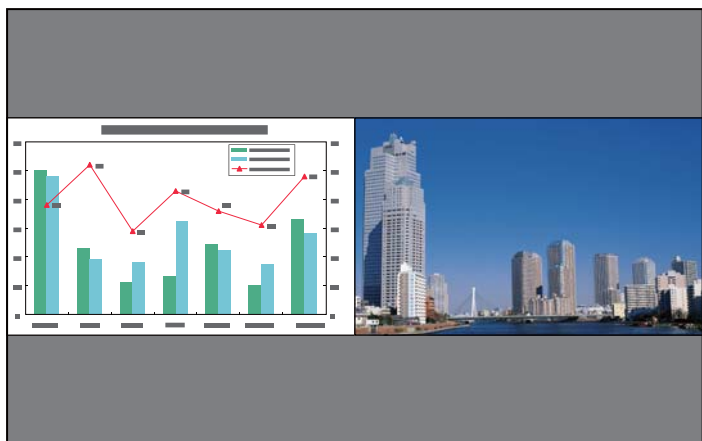

Input sources for split screen projection

The combinations of input sources that can be projected on a split screen are listed below.

| Left Screen | Right Screen | | | | | | | |
|-------------|--------------|-----------|-------------|-------|------|-------------|-----|-----|
| | Computer1 | Computer2 | DisplayPort | Video | HDMI | USB Display | USB | LAN |
| Computer1 | - | - | ✓ | ✓ | ✓ | ✓ | ✓ | ✓ |
| Computer2 | - | - | ✓ | ✓ | ✓ | ✓ | ✓ | ✓ |
| DisplayPort | ✓ | ✓ | - | ✓ | - | ✓ | ✓ | ✓ |
| Video | ✓ | ✓ | ✓ | - | ✓ | ✓ | ✓ | ✓ |
| HDMI | ✓ | ✓ | - | ✓ | - | ✓ | ✓ | ✓ |

| Left Screen | Right Screen | | | | | | | |
|-------------|--------------|-----------|-------------|-------|------|-------------|-----|-----|
| | Computer1 | Computer2 | DisplayPort | Video | HDMI | USB Display | USB | LAN |
| USB Display | ✓ | ✓ | ✓ | ✓ | ✓ | - | - | - |
| USB | ✓ | ✓ | ✓ | ✓ | ✓ | - | - | - |
| LAN | ✓ | ✓ | ✓ | ✓ | ✓ | - | - | - |

Operating procedures

Projecting on a split screen

- Press the [Split] button while projecting.
The currently selected input source is projected on the left of the screen.

Remote control

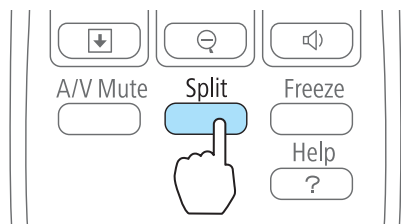

You can perform the same operations from the configuration menu.

Settings - Split Screen p.90

- Press the [Menu] button.
The Split Screen Setup screen is displayed.

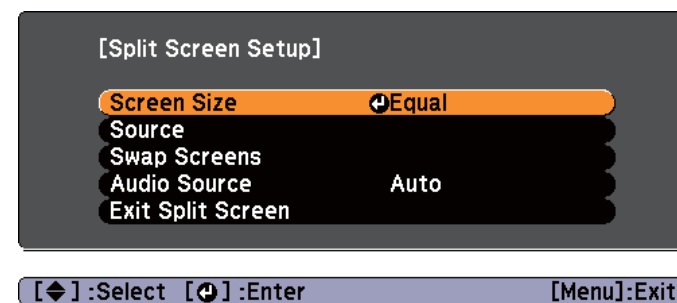

- Select the **Source**, and then press the [Enter] button.
- Select each input source for **Left** and **Right**.

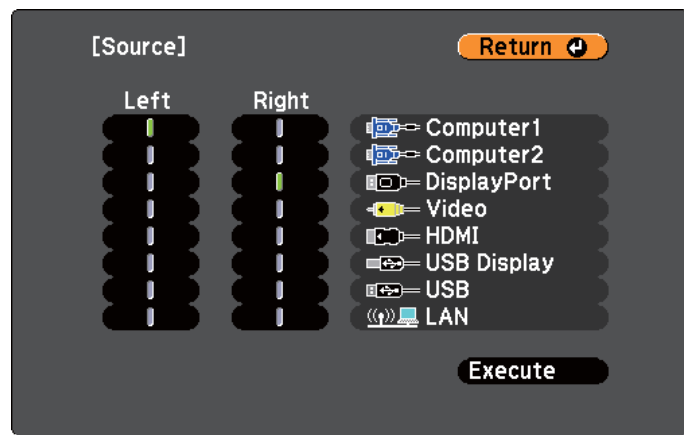

[Esc] / [Return] : Return [Down Arrow] : Select [Menu] : Exit

Only input sources that can be combined can be selected.

☛ "Input sources for split screen projection" p.49



The Source screen is also displayed when the following buttons are pressed during split screen projection.

- Source Search button
- Computer button
- Video button
- USB button
- LAN button

5 Select **Execute**, and then press the [Enter] button.

To switch the source during split screen projection, start the procedure from step 2.

Switching the left and right screens

Use the following procedure to switch the projected images displayed on the left and right screens.

1 Press the [Menu] button during split screen projection.

2 Select **Swap Screens**, and then press the [Enter] button.
The projected images on the left and right are swapped.



Switching the left and right image sizes

1 Press the [Menu] button during split screen projection.

2 Select **Screen Size**, and then press the [Enter] button.

3 Select the screen size you want to display, and then press the [Enter] button.

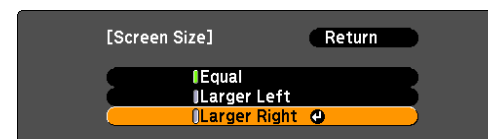

The projected images will appear as shown below after setting the screen size.

Equal

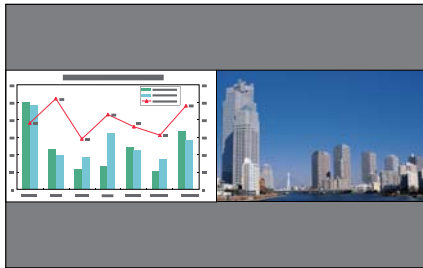

Larger Left

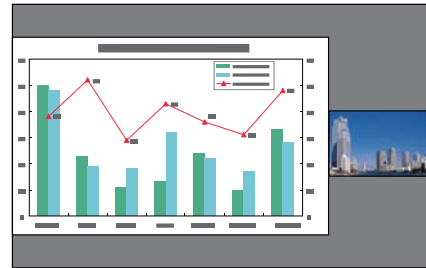

Larger Right

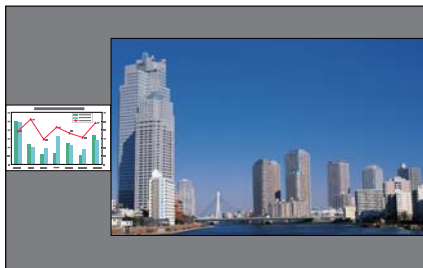

- You cannot enlarge both the left screen and right screen images at the same time.
- When one image is enlarged, the other image is reduced.
- Depending on the video signals that are input, the images on the left and right may not appear to be the same size even if **Equal** is set.

Ending the split screen

To end split screen, press the [Esc] button.

The following steps can also be used to end the split screen.

- Press the [Split] button on the remote control.
- Select **Exit Split Screen** from the configuration menu.
 **Settings - Split Screen Setup** p.90

Restrictions during split screen projection

Operating restrictions

The following operations cannot be performed during split screen projection.

- Setting the configuration menu
- E-Zoom
- Switching the aspect mode (The aspect mode will be set to **Normal**.)
- Operations using the [User] button on the remote control
- Auto Iris

Help can be displayed only when image signals are not input or when an error or warning notification is displayed.

Restriction relating to images

- The default values for the **Image** menu are applied to the image on the right screen. However, the settings for the image projected on the left screen are applied to the image on the right screen for **Color Mode**, **Abs. Color Temp.**, and **Advanced**.
- The setting value **Off** for **Progressive** and **Noise Reduction** is applied to the image on the right screen.
 "Signal Menu" p.88
- When there is no image signal input, the display screen will be the color that is set in Display Background. When **Logo** is selected, the display is **Blue**.
- When A/V Mute is performed, the display is **Black**.

Projecting Without a Computer (Slideshow)

By connecting a USB storage device such as a USB flash drives or a USB hard disk to the projector, you can project the files stored on the device without using a computer. This function is called Slideshow.



- You may not be able to use USB storage devices that incorporate security functions.
- You cannot correct keystone distortion while projecting a Slideshow, even if you press the [↖] and [↘] buttons on the control panel.

Specifications for files that can be projected using Slideshow

| Type | File Type (Ex-tension) | Notes |
|-------|------------------------|--|
| Image | .jpg | The following cannot be projected. - CMYK color mode formats - Progressive formats - Images with a resolution greater than 8192x8192 Due to the characteristics of JPEG files, images may not be projected clearly if the compression ratio is too high. |
| | .bmp | Cannot project images with a resolution greater than 1280x800. |
| | .gif | <ul style="list-style-type: none"> • Cannot project images with a resolution greater than 1280x800. • Cannot project animated GIFs. |
| | .png | Cannot project images with a resolution greater than 1280x800. |
| Movie | .avi | <ul style="list-style-type: none"> • Cannot project images with a resolution greater than 1280 x 720. • The audio format can only playback linear PCM and ADPCM. |

| Type | File Type (Ex-tension) | Notes |
|---------------|------------------------|---|
| Scenario file | .fse | PowerPoint files are converted to this format in EasyMP Slide Converter. |
| PDF contents | .pdf | <ul style="list-style-type: none"> • You can project PDF files version 1.7 or earlier. • Cannot project encrypted PDFs. |



- When connecting and using a USB-compatible hard disk, make sure you connect the AC adaptor supplied with the hard disk.
- The projector does not support some file systems, so use media that has been formatted in Windows.
- Format the media in FAT16/32.

Slideshow examples

Projecting files stored on USB storage

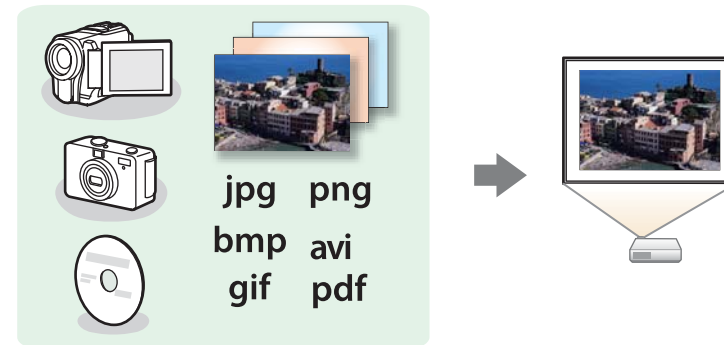

☛ "Projecting the selected images or movies" [p.56](#)

☛ "Projecting image files in a folder in sequence (Slideshow)" [p.58](#)

Projecting PowerPoint files converted in EasyMP Slide Converter

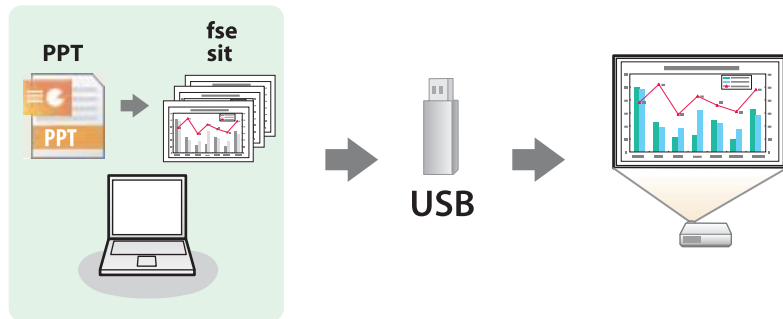



See the following manual for more information on converting PowerPoint files to scenarios using EasyMP Slide Converter.

 [EasyMP Slide Converter Operation Guide](#)

Slideshow operating methods







Although the following steps are explained based on the remote control, you can perform the same operations from the control panel.

Starting Slideshow

- 1** Change the source to USB.
 -  "Switching to the Target Image by Remote Control" [p.32](#)
- 2** Connect the USB storage device to the projector.
 -  "Connecting USB Devices" [p.25](#)

Slideshow starts and the file list screen is displayed.

- The following files are displayed as thumbnails (file contents are displayed as small images).
 - JPEG files
 - FSE files (an image of the first slide)
 - PDF files (an image of the first page of the PDF)
 - AVI files (an image 15 seconds from the start of the movie)
- Other files or folders are displayed as icons as shown in the following table.

| Icon | File | Icon | File |
|---|--------------------------|---|-----------|
|  | FSE files* |  | BMP files |
|  | JPEG files* |  | GIF files |
|  | AVI (Motion JPEG) files* |  | PNG files |
|  | PDF files* | | |

* When it cannot be displayed as a thumbnail, it is displayed as an icon.



- You can also insert a memory card into a USB card reader and then connect the reader to the projector. However, some commercially available USB card readers may not be compatible with the projector.
- If the following screen (Select Drive screen) is displayed, press the [↶], [↷], [↵], or [↶] button to select the drive you want to use, and then press the [↵] button.

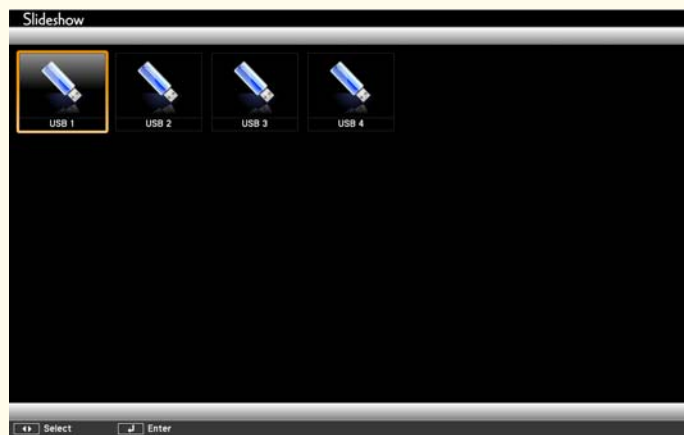

- To display the Select Drive screen, position the cursor on **Select Drive** at the top of the file list screen, and then press the [↵] button.

Projecting images

- 1 Press the [↶], [↷], [↵], or [↶] button to select the file or folder you want to project.



If not all of the files and folders are displayed on the current screen, press the [⏪] button on the remote control, or position the cursor on **Next Page** at the bottom of the screen and press the [↵] button.

To return to the previous screen, press the [⏩] button on the remote control, or position the cursor on **Previous Page** at the top of the screen and press the [↵] button.

- 2 Press the [↵] button.

The selected image is displayed.

When a folder is selected, the files in the selected folder are displayed. To return to the previous screen, position the cursor on **Back to Top** and press the [↵] button.

Rotating images

You can rotate the played images in 90° increments. The rotating function is also available during Slideshow.

- 1 Display images or run Slideshow.

2 While projecting, press the [↶] or [↷] button.

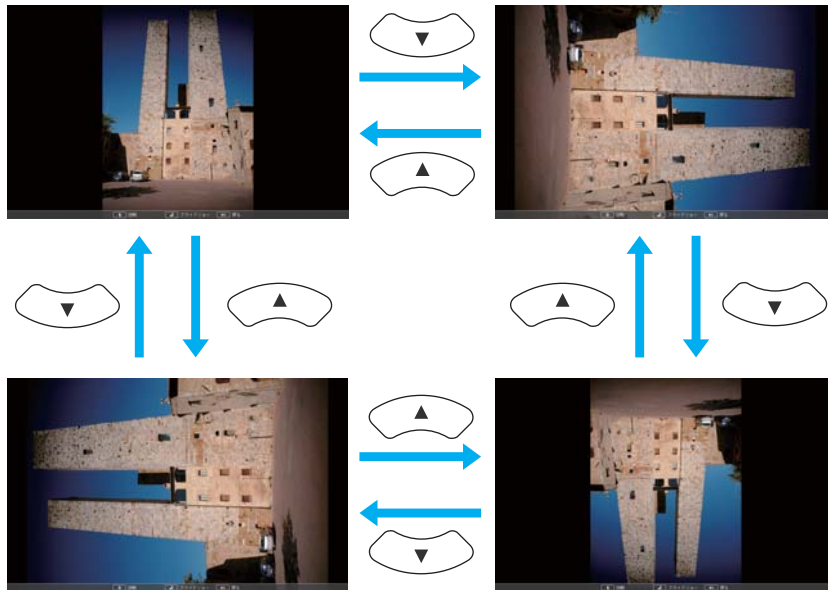

Stopping Slideshow

To close Slideshow, disconnect the USB device from the USB port on the projector. For devices such as digital cameras or hard disks, turn off the device and then remove it from the projector.

Projecting the selected images or movies

Attention

Do not disconnect the USB storage device while it is being accessed. Slideshow may not operate correctly.

1 Start Slideshow.
The file list screen is displayed.
☛ "Starting Slideshow" p.54

2 Press the [↶], [↷], [⏪], or [⏩] button to select the file you want to project.



3 Press the [↵] button.
The image is displayed or the movie is played back.



☛ Press the [⏪] [⏩] buttons to move to the next or previous image file.

- 4** To finish projecting, perform one of the following operations.
- Projecting an image: Press the [Esc] button.
 - Projecting a movie: Press the [Esc] button to display the message screen, select **Exit**, and then press the [**↵**] button.
- When projection is finished, you are returned to the file list screen.

Projecting PDF files

You can project PDF files using slideshow. In PDF files, you can move pages up or down, enlarge, or rotate.

- 1** Start Slideshow.
The file list screen is displayed.
☞ "Starting Slideshow" p.54
- 2** Press the [**△**], [**▽**], [**◀**], or [**▶**] button to select the PDF file you want to project.



If the file extension is not .pdf, the file is not displayed in the file list.

- 3** Press the [**↵**] button.
The first page in the PDF file is displayed at full screen size.



You can perform the following operations while a PDF file is displayed.

- Page Up/Down
While a page is displayed at full screen size, press the [**△**] or [**▽**] button to go to the previous or next page.

- Selecting a page

Press the [Esc] button to display the select page menu.



Select the page you want to project using the [⏪] or [⏩] button, and then press the [↵] button to display the selected page.

If you press the [Esc] button while the select page menu is displayed, the menu closes.

- Expanding a page

While a page is displayed at full screen size, press the [↵] button to expand the image.

Portrait pages are expanded horizontally to fit the width of the screen, and landscape pages are expanded vertically to fit the height of the screen.

While a page is displayed at expanded size, press the [↵] button to return to standard full screen size display.

- Scrolling a page

While a page is displayed at expanded size, press the [⏪][⏩][⏪][⏩] button to scroll the page.

- Rotating a page

While a page is displayed at full screen size, press the [⏪] or [⏩] button to rotate all pages in the PDF by 90 degrees.

Closing PDF file display

- 1 Press the [Esc] button while a PDF file is being displayed. The select page menu is displayed.

- 2 Press the [⏪] or [⏩] button to select **EXIT**.

- 3 Press the [↵] button.

The PDF file being displayed closes and the file select screen is displayed.



The following operations cannot be performed while viewing a PDF in Slideshow.

- Releasing a password
- Displaying e-signatures
- Displaying JPEG2000 images
- Displaying transparent effects
- Playing multi media contents
- Displaying 3D artwork
- Displaying comments

Projecting image files in a folder in sequence (Slideshow)

You can project the image files in a folder in sequence, one at a time. This function is called Slideshow. Use the following procedure to run Slideshow.



To change files automatically when you run Slideshow, set **Screen Switching Time** from **Option** in Slideshow to anything other than **No**. The default setting is 3 seconds.

☛ "Image file display settings and Slideshow operation settings" p.60

- 1 Start Slideshow.
The file list screen is displayed.
☛ "Starting Slideshow" p.54

- 2 Press the [⏪], [⏩], [⏴], or [⏵] button to position the cursor over the folder for the Slideshow that you want to run, and then press the [↵] button.

- 3 Select **Slideshow** at the bottom right of the file list screen, and then press the [↵] button.
Slideshow starts, and the image files in the folder are automatically projected in sequence, one at a time.

When the last file is projected, the file list is displayed again automatically. If you set **Continuous Play** to **On** in the Option window, projection starts again from the beginning when it reaches the end.

☛ "Image file display settings and Slideshow operation settings" p.60

You can proceed to the next screen, return to the previous screen, or stop playback while projecting a Slideshow.



If **Screen Switching Time** on the Option screen is set to **No**, files do not change automatically when you select Play Slideshow. Press the [⏪] button, the [↵] button, or the [⏩] button to display the next file.

Playing a scenario

- 1 Start Slideshow.
The file list screen is displayed.
☛ "Starting Slideshow" p.54
- 2 Press the [⏪], [⏩], [⏴], or [⏵] button to select the scenario you want to playback.
- 3 Press the [↵] button.
Playback starts.

Operations while playing a scenario

To switch screens

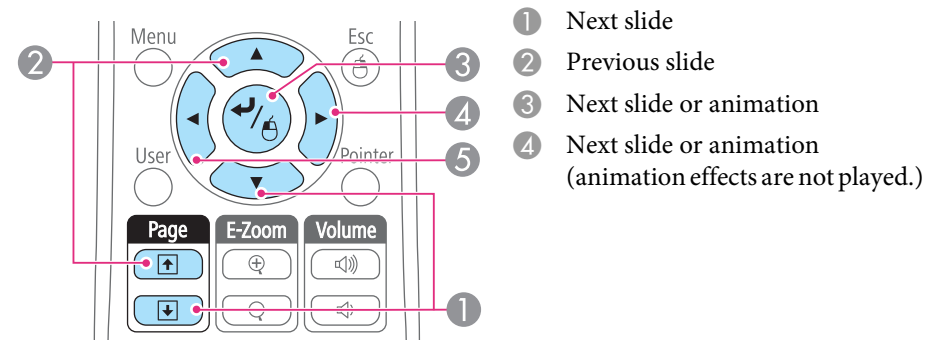

- 5 Previous slide or animation
(animation effects are not played.)

To stop playback

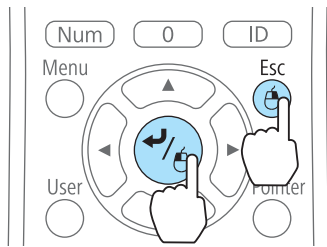

When you press the [Esc] button, the message "Do you want to quit playing the scenario?" is displayed. Select **Exit**, and then press the [Enter] button to confirm your selection. Select **Return**, and then press the [Enter] button to continue playing the file.

You can use the following functions when projecting a file with Slideshow.

- Freeze
☛ "Freezing the Image (Freeze)" [p.61](#)
- A/V Mute
☛ "Hiding the Image and Sound Temporarily (A/V Mute)" [p.61](#)
- E-Zoom
☛ "Enlarging Part of the Image (E-Zoom)" [p.63](#)
- Pointer
☛ "Pointer Function (Pointer)" [p.62](#)

Image file display settings and Slideshow operation settings

You can set the file display order and Slideshow operations on the Option screen.

- 1 Select **Option** at the bottom of the file list screen, and then press the [] button.

- 2 When the following Option screen is displayed, set each of the items.

Select any of the options as necessary and press the [] button. The following table shows the details for each item.

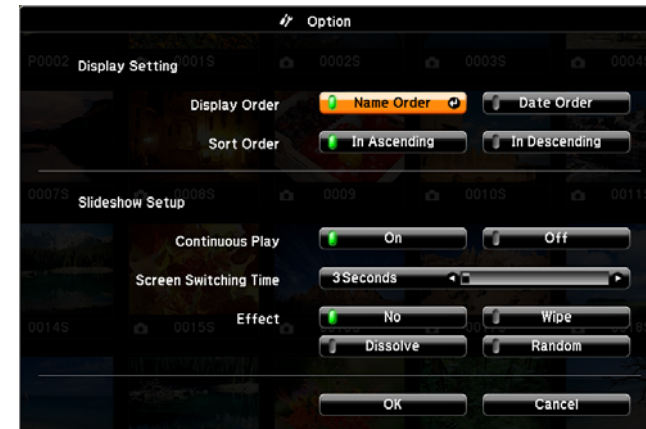

| | |
|------------------------------|--|
| Display Order | You can select to display the files in Name Order or Date Order . |
| Sort Order | You can select to sort the files In Ascending or In Descending order. |
| Continuous Play | You can set whether to repeat the Slideshow. |
| Screen Switching Time | You can set the time before a file switches to the next file in Slideshow. You can set a time between No (0) to 60 Seconds. When you set No , auto play is disabled. |
| Effect | You can set the screen effects when changing slides. |

- 3** When you have finished making settings, press the [↶], [↷], [↵], or [↶] button to position the cursor over **OK**, and then press the [↵] button.

The settings are applied.

If you do not want to apply the settings, position the cursor on **Cancel**, and then press the [↵] button.

Hiding the Image and Sound Temporarily (A/V Mute)

You can use this when you want to focus the audience's attention on what you are saying, or if you do not want to show details such as when you are changing between files during presentations from a computer.

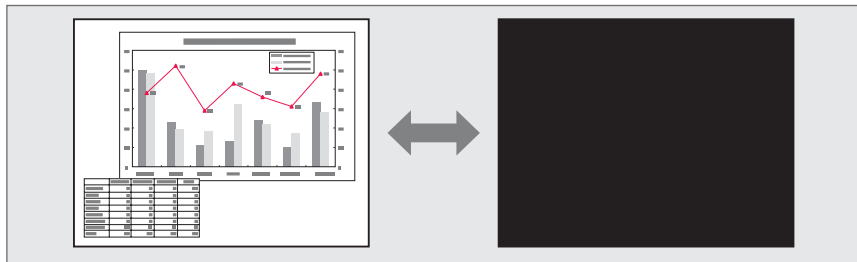

Each time you press the [A/V Mute] button or open/close the lens cover, A/V Mute turns on or off.

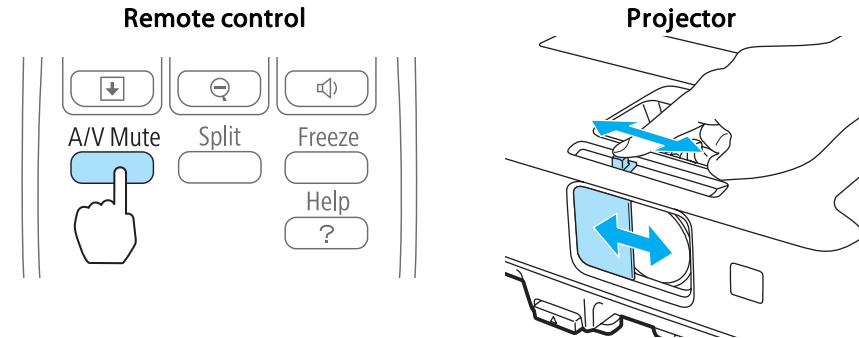

- When projecting moving images, the images and sound continue to be played back while A/V Mute is on. It is not possible to resume projection from the point where A/V Mute was activated.
- You can select the screen displayed when the [A/V Mute] button is pressed from the Configuration menu.
 - **Extended - Display - A/V Mute p.91**
- When the A/V mute slide is closed for approximately 30 minutes, Lens Cover Timer activates and the power is automatically turned off. If you do not want Lens Cover Timer to activate, set **Lens Cover Timer** to **Off**.
 - **Extended - Operation - Lens Cover Timer p.91**
- The lamp is still lit during A/V Mute, so the lamp hours continue to accumulate.

Freezing the Image (Freeze)

When Freeze is activated on moving images, the frozen image continues to project on the screen, so you can project a moving image one frame at a time like a still photo. Also, you can perform operations such as changing between files during presentations from a computer without projecting any images if the Freeze function is activated beforehand.

Each time you press the [Freeze] button, Freeze turns on or off.

Remote control

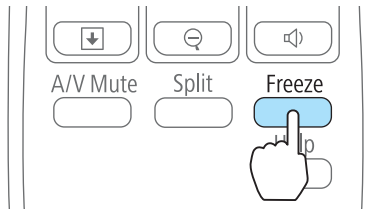

- Audio does not stop.
- When projecting moving images, the images continue to be played back while the screen is frozen. It is not possible to resume projection from the point where the screen was frozen.
- If the [Freeze] button is pressed while the Configuration menu or the Help screen is displayed, the menu or the Help screen that is displayed is closed.
- Freeze still works while E-Zoom is being used.

Pointer Function (Pointer)

This allows you to move a Pointer icon on the projected image, and helps you draw attention to the area you are talking about.

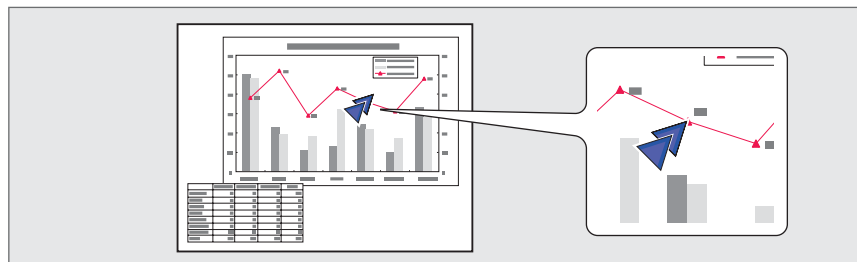

1 Display the Pointer.

Each time you press the [Pointer] button, the pointer appears or disappears.

Remote control

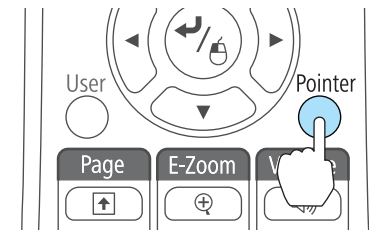

2 Move the Pointer icon (↗).

Remote control

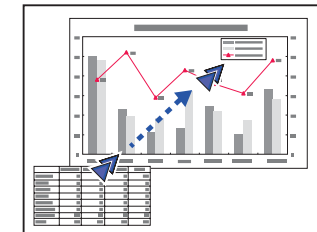
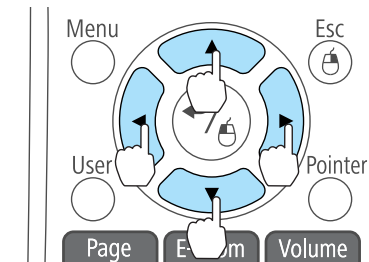

When any pair of adjacent [↖], [↘], [↙], or [↗] buttons are pressed at the same time, the pointer can be moved diagonally.



You can select the shape of the pointer icon from the Configuration menu.

🖱 **Settings - Pointer Shape** [p.90](#)

Enlarging Part of the Image (E-Zoom)

This is useful when you want to expand images to see them in greater detail, such as graphs and tables.

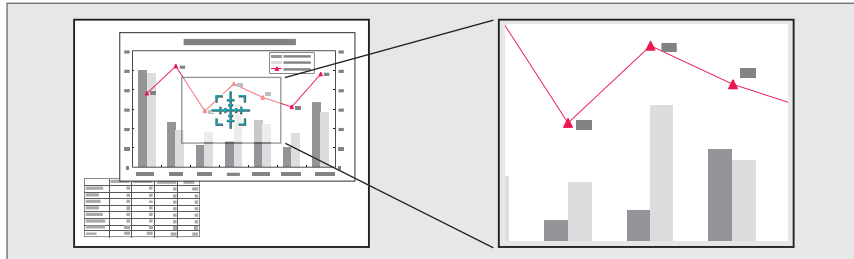

1 Start E-Zoom.

Press the [⊕] button to display the Cross (⊕).

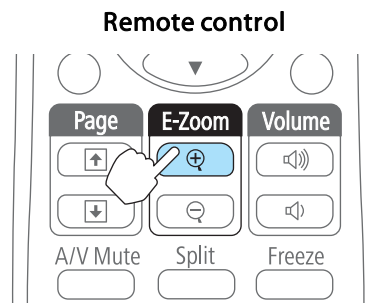

2 Move the Cross (⊕) to the area of the image that you want to enlarge.

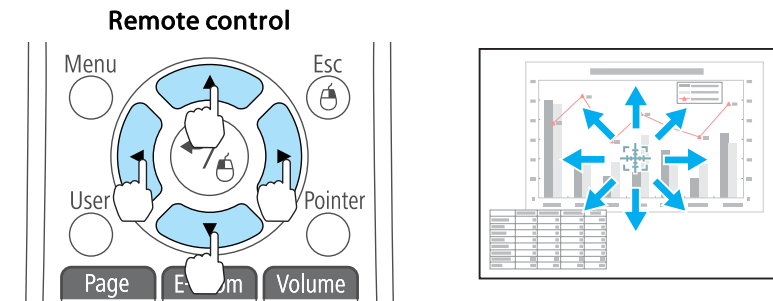

When any pair of adjacent [⬅️], [⬇️], [⬅️], or [⬆️] buttons are pressed at the same time, the pointer can be moved diagonally.

3 Enlarge.

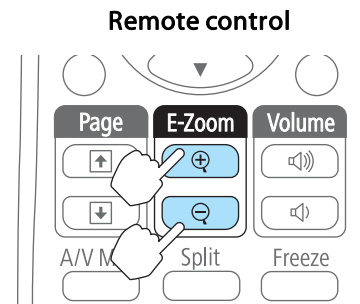

[⊕] button: Expands the area each time it is pressed. You can expand quickly by holding the button down.

[⊖] button: Reduces images that have been enlarged.

[Esc] button: Cancels E-Zoom.



- The enlargement ratio appears on the screen. The selected area can be enlarged to between 1 to 4 times in 25 incremental steps.
- During enlarged projection, press the [⬅️], [⬇️], [⬅️], or [⬆️] button to scroll the image.

Using the Remote Control to Operate the Mouse Pointer (Wireless Mouse)

You can control the computer's mouse pointer from the projector's remote control. This function is called Wireless Mouse.

The following operating systems are compatible with Wireless Mouse.

| | Windows | Mac OS X |
|----|--|---|
| OS | Windows 2000 Windows XP Windows Vista Windows 7 | Mac OS X 10.3.x Mac OS X 10.4.x Mac OS X 10.5.x Mac OS X 10.6.x Mac OS X 10.7.x |

* It may not be possible to use the Wireless Mouse function under some versions of the operating systems.





Use the following procedure to enable the Wireless Mouse function.

- 1** Connect the projector to the computer with a commercially available USB cable.
 - ☛ "Connecting a Computer" [p.23](#)
- 2** Change the source to one of the following.
 - USB Display
 - Computer
 - HDMI
 - DisplayPort
 - ☛ "Switching to the Target Image by Remote Control" [p.32](#)

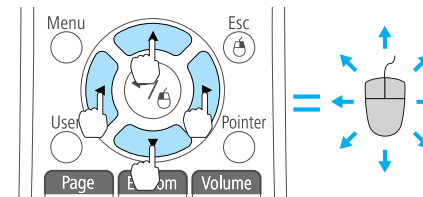
Once set, the mouse pointer can be controlled as follows.

Moving the mouse pointer



[][][][] buttons:
Moves the mouse pointer.



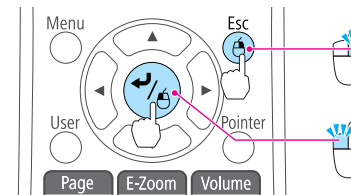



Mouse clicks

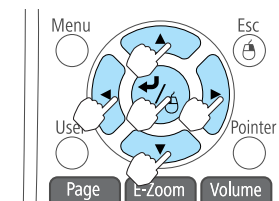

[Esc] button: Right click.
[] button: Left click. Press quickly twice to double-click.



Drag and drop

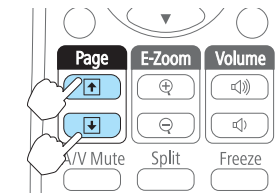

While holding down the [] button, press the [], [], [], or [] button.
Release the [] button to drop at the desired location.

Page Up/Down



[] button: Moves to the previous page.
[] button: Moves to the next page.



- When any pair of adjacent [↶], [↷], [↵], or [↶] buttons are pressed at the same time, the pointer can be moved diagonally.
- If the mouse button settings are set to reverse on the computer, the operation of the remote control buttons will also be reversed.
- The Wireless Mouse function does not work under the following conditions.
 - When the Configuration menu or a Help screen is displayed
 - When operating functions other than the Wireless Mouse function (such as adjusting the volume).
 However, when using the E-Zoom or Pointer function, the page up or down function is available.

Correcting the Color Difference when Projecting from Multiple Projectors

When multiple projectors are lined up and projecting images, you can correct the brightness and color tone of each projector's image with multi-screen color adjustment so that the colors of images from each projector match closely.



In some cases the brightness and color tone may not match completely even after correction.

Summary of correction procedure

When multiple projectors are set up and you need to make corrections, use the following procedure to correct one projector at a time.

1. Set the projector ID.

Set a unique projector ID for the target projector so that you can limit which projector is being corrected.

2. Correct the color difference.

You can carry out color correction when projecting from multiple projectors. You can adjust from black to white in five stages called levels 1 to 5, and in each of these 5 levels you can adjust the following two points.



- Correcting brightness
 - You can correct the image brightness to make them all equal.
- Correcting color
 - You can correct the image color so that they match closely.

Setting an ID and using the remote control

By setting an ID for each projector, you can limit which projector is operated from the remote control.

You can set an ID for the projector within a range of "1" to "9". The default value is off.

On the remote control, select the Projector ID from 0 to 9 for the projector you want to operate. The following examples show the combination of IDs for the Projector ID and the ID selected with the remote control.

| Operation | Combinations | | Descriptions |
|-----------|---|------------------------------------|---|
| Possible |  | Projector ID: 1 | When the Projector ID and the ID selected with the remote control match, you can operate the projector from the remote control. |
| |  | ID selected with remote control: 1 | |
| Possible |  | Projector ID: Off | When the Projector ID is set to Off, you can operate the projector regardless of the ID selected with the remote control. |

| Operation | Combinations | | Descriptions |
|--------------|--------------|------------------------------------|---|
| | | ID selected with remote control: 1 | |
| Possible | | Projector ID: 1 | When 0 is selected with the remote control, you can operate the projector from the remote control regardless of the Projector ID. |
| | | ID selected with remote control: 0 | |
| Not possible | | Projector ID: 1 | When the Projector ID and the ID selected with the remote control do not match, you cannot operate the projector from the remote control. |
| | | ID selected with remote control: 3 | |

Setting the projector ID

1 Press the [Menu] button while projecting.

☛ "Using the Configuration Menu" p.85

Using the remote control

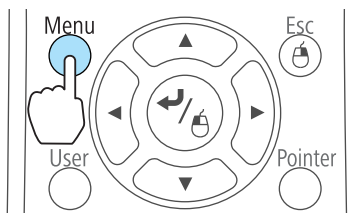

Using the control panel

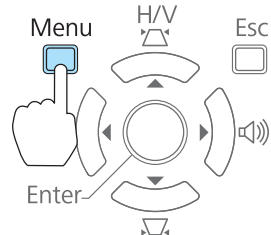

2 Select **Projector ID** from **Extended**.

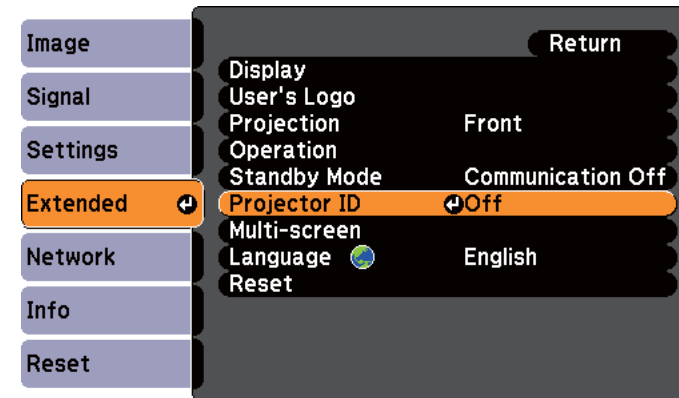

[Esc] :Return [◆] :Select [↵] :Enter [Menu]:Exit

3 Select the ID you want to set, and then press the [Enter] button.

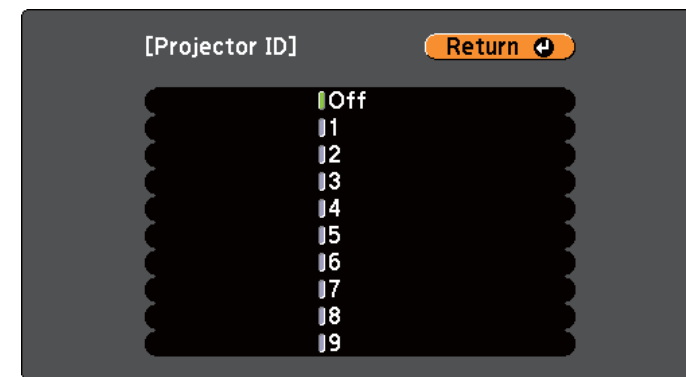

[Esc] / [Enter] :Return [◆] :Select [Menu]:Exit

4 Press the [Menu] button to finish making settings.

Selecting the ID for the projector you want to operate using the remote control



Select the ID each time you turn on the projector. When the projector is turned on, the ID set for the remote control is 0.

- 1 Point the remote control at the remote receiver of the target projector and press the [ID] button on the remote control.
When you press the [ID] button, the current Projector ID is displayed on the projection screen. It disappears in about three seconds.

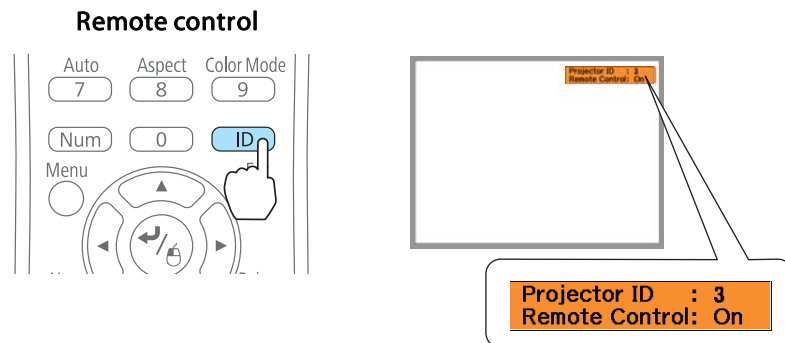

- 2 While holding the [ID] button, press the number button that matches the ID of the projector you want to operate.

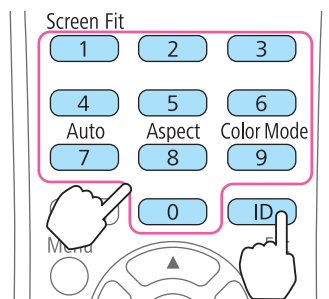

The projector you want to operate is selected.

Correcting

After setting up the projectors, correct the brightness and tone for each projector to reduce the differences.

- 1 Press the [Menu] button.
☛ "Using the Configuration Menu" p.85
- 2 Select **Multi-screen** from **Extended**.

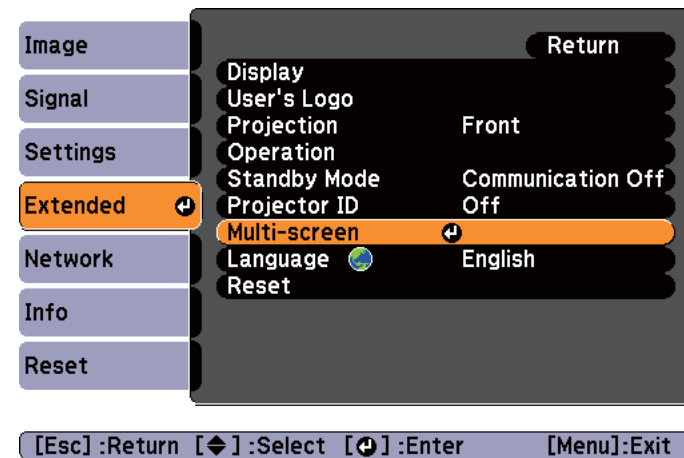

- 3 Select the level to be corrected in **Adjustment Level**.
 - Each time a level is selected, the pattern of the level selected is displayed.
 - You can start correcting from any level, usually you can make it darker or lighter by correcting 1 to 5 or 5 to 1.
- 4 Correct the brightness with **Brightness Correct**.

- When you select **Level 5**, adjust the brightness to match the darkest image.
- When you select **Level 1**, adjust the brightness to match the brightest image.
- When you select **Level 2** to **Level 4**, adjust the brightness to the mid-range brightness image.
- Because you can switch between a pattern display and the normal image each time you press the [Enter] button, you can check the correction results and correct the brightness in the actual image.

- 5** Adjusting **Color Correct. (G/R)** and **Color Correct. (B/Y)**.
- 6** Repeat procedures 3 to 5 until corrections are finished.
- 7** When all corrections are finished, press the [Menu] button to finish making settings.

Saving a User's Logo

You can save the image that is currently being projected as a User's Logo.



Once a User's Logo has been saved, the logo cannot be returned to the factory default.

- 1** Project the image you want to save as the User's Logo, and then press the [Menu] button.

☛ "Using the Configuration Menu" p.85

Using the remote control

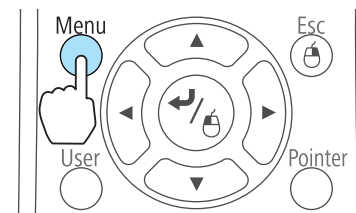

Using the control panel

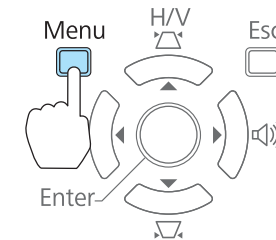

- 2** Select **User's Logo** from **Extended**.

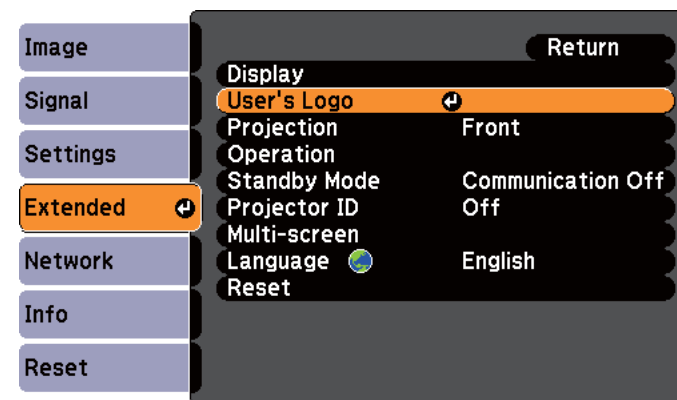

[Esc]:Return [◆]:Select [↵]:Enter [Menu]:Exit



- When **User's Logo Protect** from **Password Protect** is set to **On**, a message is displayed and the User's Logo cannot be changed. You can make changes after setting **User's Logo Protect** to **Off**.

☞ "Managing Users (Password Protect)" p.70

- If **User's Logo** is selected when Keystone, E-Zoom, Aspect, or Adjust Zoom are being performed, the function currently being performed is temporarily cancelled.

- 3** When the message "Choose this image as the User's Logo?" is displayed, select **Yes**.



When you press the [↵] button on the remote control or the control panel, the screen size may change depending on the signal to match the actual resolution of the image signal.

- 4** Move the box to select the part of the image to use as the User's Logo.

You can perform the same operations from the projector's control panel.

Remote control

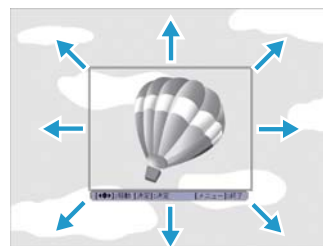
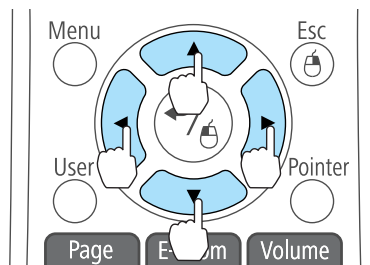

You can save at 400x300 dots in size.

- 5** When you press the [↵] button and the message "Select this image?" is displayed, select **Yes**.

- 6** Select the zoom factor from the zoom setting screen.

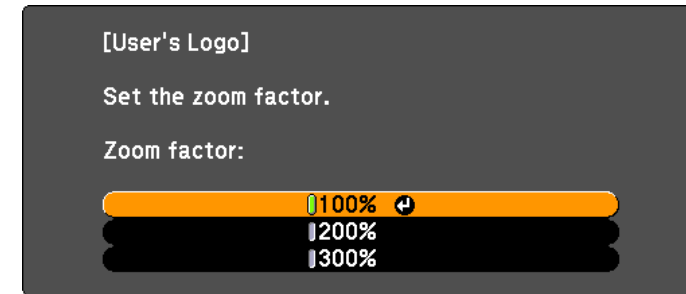

[Esc]:Return [◆]:Select [⊕]:Set [Menu]:Exit

- 7** When the message "Save this image as the User's Logo?" is displayed, select **Yes**.

The image is saved. After the image has been saved, the message "Completed." is displayed.



- When a User's Logo is saved, the previous User's Logo is erased.
- It takes a while to save. Do not operate the projector or any connected equipment while it is saving, otherwise malfunctions may occur.

The projector has the following enhanced security functions.

- **Password Protect**
You can limit who can use the projector.
- **Control Panel Lock**
You can prevent people changing the settings on the projector without permission.
☛ "Restricting Operation (Control Panel Lock)" [p.72](#)
- **Anti-Theft Lock**
The projector is equipped with the following anti-theft security device.
☛ "Anti-Theft Lock" [p.73](#)

Managing Users (Password Protect)

When Password Protect is activated, people who do not know the password cannot use the projector to project images even if the projector power is on. Furthermore, the user's logo that is displayed when you turn on the projector cannot be changed. This acts as an anti-theft function as the projector cannot be used even if it is stolen. At the time of purchase, Password Protect is not activated.

Kinds of Password Protect

The following three kinds of Password Protect settings can be made according to how the projector is being used.

- **Power On Protect**
When **Power On Protect** is **On**, you need to enter a preset password after the projector is plugged in and turned on (this also applies to Direct Power On). If the correct password is not entered, projection does not start.

- **User's Logo Protect**

Even if someone tries to change the User's Logo set by the owner of the projector, it cannot be changed. When **User's Logo Protect** is set to **On**, the following setting changes for the User's Logo are prohibited.

- Capturing a User's Logo
- Setting **Display Background**, **Startup Screen**, or **A/V Mute** from **Display**
☛ **Extended - Display** [p.91](#)

- **Network Protect**

When **Network Protect** is set to **On**, changing the settings for **Network** is prohibited.

- ☛ "Network Menu" [p.93](#)

Setting Password Protect

Use the following procedure to set Password Protect.

- 1** During projection, hold down the [Freeze] button for about five seconds.

The Password Protect setting menu is displayed.

Remote control

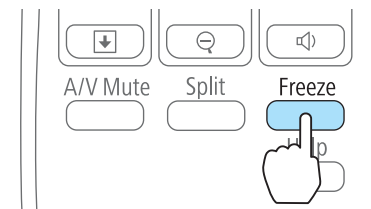



- If Password Protect is already activated, you must enter the password.
If the password is entered correctly, the Password Protect setting menu is displayed.
- "Entering the Password" p.71
- When the password is set, stick the supplied password protect sticker in a visible position on the projector as a further theft deterrent.

- 2 Select the type of Password Protect you want to set, and then press the [↵] button.

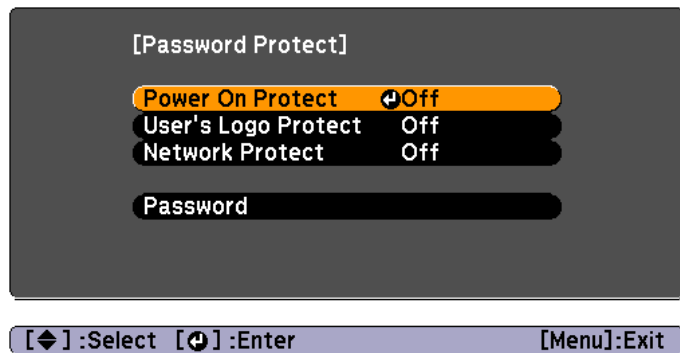

- 3 Select **On**, and then press the [↵] button.
Press the [Esc] button, the screen displayed in step 2 is displayed again.

- 4 Set the password.
 - (1) Select **Password**, and then press the [↵] button.
 - (2) When the message "Change the password?" is displayed, select **Yes** and then press the [↵] button. The default password is set to "0000". Change this to your own desired Password. If you select **No**, the screen displayed in step 2 is displayed again.

- (3) While holding down the [Num] button, enter a four digit number using the numeric buttons. The number entered is displayed as "****". When you enter the fourth digit, the confirmation screen is displayed.

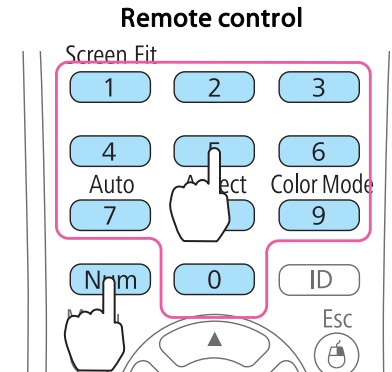

- (4) Re-enter the password.
The message "Password accepted." is displayed.
If you enter the password incorrectly, a message is displayed prompting you to re-enter the password.

Entering the Password

When the password entry screen is displayed, enter the password using the remote control.

While holding down the [Num] button, enter the password by pressing the numeric buttons.

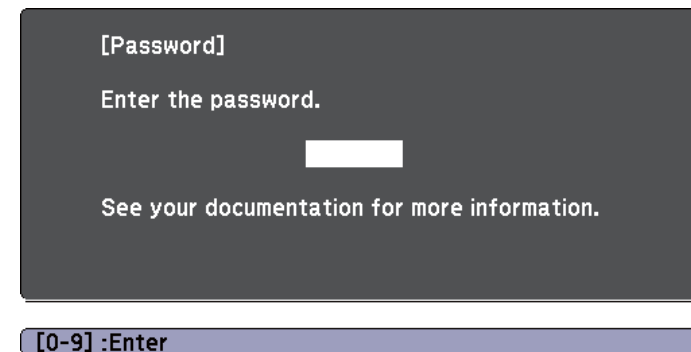

When you enter the correct password, Password Protect is temporarily released.

Attention

- If an incorrect password is entered three times in succession, the message "The projector's operation will be locked." is displayed for approximately five minutes, and then the projector switches to standby mode. If this happens, disconnect the power plug from the electrical outlet and then reinsert it and turn the projector's power back on. The projector displays the password entry screen again so that you can enter the correct password.
- If you have forgotten the password, make a note of the "Request Code: xxxxx" number that appears on the screen and contact the nearest address provided in the Epson Projector Contact List.
[Epson Projector Contact List](#)
- If you continue to repeat the above operation and input the wrong password thirty times in succession, the following message is displayed and the projector does not accept any more password entries. "The projector's operation will be locked. Contact Epson as described in your documentation."
[Epson Projector Contact List](#)

Restricting Operation (Control Panel Lock)

Perform one of the following to lock the operation buttons on the control panel.

- **Full Lock**
 All of the buttons on the control panel are locked. You cannot perform any operations from the control panel, including turning the power on or off.
- **Partial Lock**
 All of the buttons on the control panel, except for the [⏻] button, are locked.

This is useful at events or shows when you want to deactivate all buttons during projection or at schools when you want to limit button operation. The projector can still be operated using the remote control.

- 1 Press the [Menu] button while projecting.
 "Using the Configuration Menu" p.85

Using the remote control

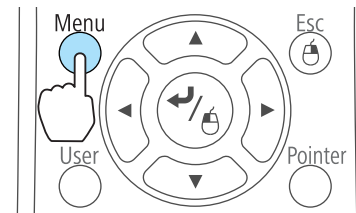

Using the control panel

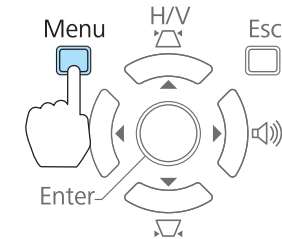

- 2 Select **Control Panel Lock** from **Settings**.

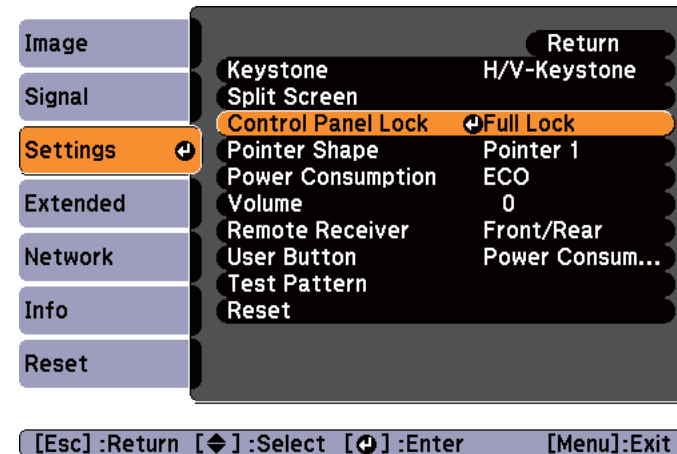

- 3 Select either **Full Lock** or **Partial Lock** according to your purpose.

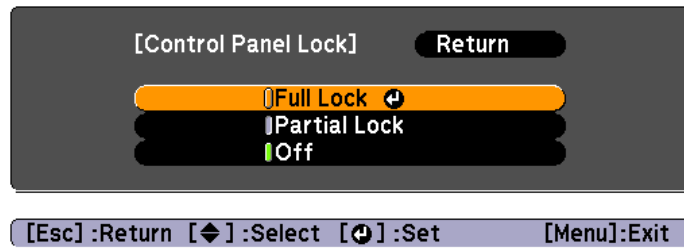

- 4** Select **Yes** when the confirmation message is displayed. The control panel buttons are locked according to the setting you chose.



You can release the control panel lock by one of the following two methods.

- Select **Off** from **Control Panel Lock**.
 **Settings - Control Panel Lock** p.90
- Press and hold down the [Left Arrow] button on the control panel for about seven seconds, a message is displayed and the lock is released.

Anti-Theft Lock

The projector is equipped with the following types of anti-theft security devices.

- Security slot
 The security slot is compatible with the Microsaver Security System manufactured by Kensington.
 See the following for more details on the Microsaver Security System.
 <http://www.kensington.com/>
- Security cable installation point
 A commercially available theft-prevention wire lock can be passed through the installation point to secure the projector to a desk or pillar.

Installing the wire lock

Pass an anti-theft wire lock through the installation point.

See the documentation supplied with the wire lock for locking instructions.

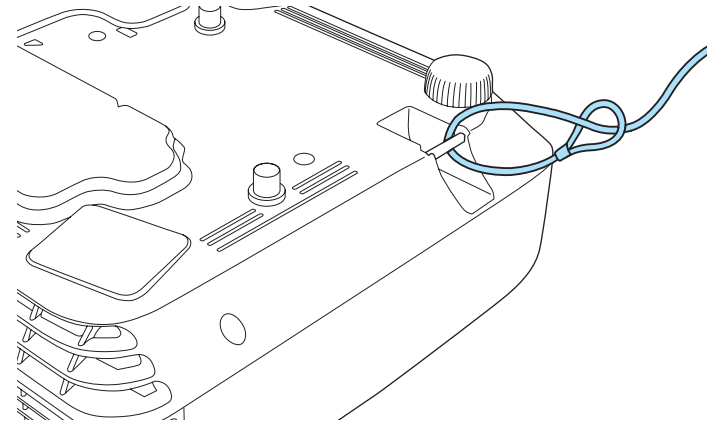

About EasyMP Monitor

EasyMP Monitor lets you carry out operations such as checking the status of multiple Epson projectors that are connected to a network at a computer monitor, and controlling the projectors from the computer.

You can download EasyMP Monitor from the following Web site.

<http://www.epson.com>

The following provides brief descriptions of the monitoring and control functions that can be carried out using EasyMP Monitor.

- **Registering projectors for monitoring and control**

Projectors on the network can be searched for automatically, and you can then select which projectors you want to register from the projectors that are detected.

You can register target projectors by entering their IP addresses.

- **Registered projectors can also be assigned to groups so that they can be monitored and controlled in groups.**

- **Monitoring the status of registered projectors**

You can check the power status (ON/OFF) for projectors and problems or warnings that require attention by using the icons.

You can select groups of projectors or a single projector and then check the cumulative lamp operating time or information such as input sources, problems, and warnings for the projectors.

- **Controlling registered projectors**

Projectors can be selected in groups or as single projectors, and you can then carry out operations for the selected projectors such as turning the power on and off and switching their input sources.

You can use Web Control functions to change the settings in the projector's configuration menu.

If there are certain control actions which are carried out regularly at particular times or on particular days, you can use Timer Settings to register timer settings.

- **Mail Notification settings**

You can set email addresses to which notifications are sent if a status that requires attention, such as a problem, occurs with a registered projector.

- **Sending messages to registered projectors**

You can use the Message Broadcasting plugin for EasyMP Monitor to send JPEG files to registered projectors.

Download the Message Broadcasting plugin from the Web site address provided at the beginning of this chapter.

Changing Settings Using a Web Browser (Web Control)

By using the Web browser of a computer connected to the projector on a network, you can make settings and control the projector. This function allows you to perform setup and control operations remotely. In addition, since you can use the computer's keyboard, entering characters required for the setup is easier.

Use Microsoft Internet Explorer 6.0 or later as the Web browser. If using a Mac OS X, use Safari.



If you set **Standby Mode** to **Communication On**, you can use the Web browser to make settings and perform control even if the projector is in standby mode (when the power is off).

 **Extended - Standby Mode** [p.91](#)

Projector setup

In the Web browser, you can set items that are usually set in the projector's Configuration menu. The settings are reflected in the Configuration menu. There are also items that can only be set in the Web browser.

Items in the Configuration menu that cannot be set by the Web browser

- Settings Menu - Test Pattern
- Settings Menu - Pointer Shape
- Settings Menu - User Button
- Extended Menu - User's Logo
- Extended Menu - Language
- Extended Menu - Operation - High Altitude Mode
- Extended Menu - Operation - Lens Cover Timer
- Reset Menu - Reset All and Reset Lamp Hours

The settings for items on each menu are the same as the projector's Configuration menu.

☞ "Configuration Menu" [p.84](#)

Items that can only be set with a Web browser

- SNMP Community Name (up to 32 single-byte alphanumeric characters)
- Monitor Password (up to 16 single-byte alphanumeric characters)

Displaying the Web Control screen

Use the following procedure to display the Web Control screen.

Make sure the computer and projector are connected to the network.



If your Web browser is set up to connect via a proxy server, the Web Control screen cannot be displayed. To display Web Control, you need to make settings so that a proxy server is not used for a connection.

- 1 Start the Web browser on the computer.

- 2 Enter the IP address of the projector in the address input box of the Web browser, and press the Enter key on the computer's keyboard.

The Web Control screen is displayed.

When Web Control Password is set in the Network menu from the projector's Configuration menu, the password entry screen is displayed.

- 3 The user ID and password entry screen is displayed.

Enter "EPSONWEB" as the user ID.

The default password is "admin".



- Enter the user ID even if the password setting is disabled. You cannot change the user ID.
 - You can change the password in Network menu from the Configuration menu.
- ☞ **Network - Basic - Web Control Password** [p.95](#)

Displaying the Web Remote screen

The Web Remote function allows you to perform projector remote control operations with a Web browser.

- 1 Display the Web Control screen.

- 2 Click **Web Remote**.

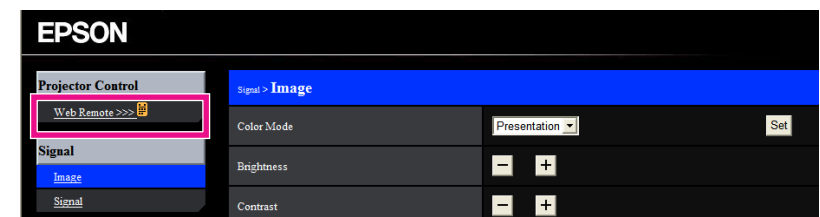

3 The Web Remote screen is displayed.

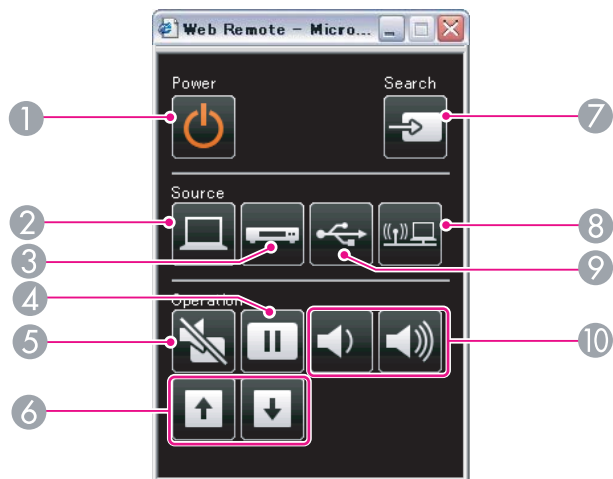

| Name | Function |
|---------------------|--|
| 1 [Power] button | Turns the projector power on or off. ☛ "From Installation to Projection" p.30 |
| 2 [Computer] button | Each time the button is pressed, it cycles through the following images: <ul style="list-style-type: none"> • Computer1 port • Computer2 port • DisplayPort |
| 3 [Video] button | Each time the button is pressed, it cycles through the following images: <ul style="list-style-type: none"> • Video port • HDMI port |
| 4 [Freeze] button | Images are paused or unpaused. ☛ "Freezing the Image (Freeze)" p.61 |
| 5 [A/V Mute] button | Turns the video and audio on or off. ☛ "Hiding the Image and Sound Temporarily (A/V Mute)" p.61 |

| Name | Function |
|------------------------------------|--|
| 6 [Page] buttons [Up] [Down] | Changes pages in files such as PowerPoint files when using the following projection methods. <ul style="list-style-type: none"> • When using the Wireless Mouse function <ul style="list-style-type: none"> ☛ "Using the Remote Control to Operate the Mouse Pointer (Wireless Mouse)" p.64 • When using USB Display <ul style="list-style-type: none"> ☛ "Projecting with USB Display" p.32 • When connecting to a network When projecting images using Slideshow, pressing these buttons displays the previous/next screen. |
| 7 [Source Search] button | Changes to the next input source that is sending an image. ☛ "Automatically Detect Input Signals and Change the Projected Image (Source Search)" p.31 |
| 8 [LAN] button | Switches to the image from the network connected device. ☛ "Switching to the Target Image by Remote Control" p.32 |
| 9 [USB] button | Each time the button is pressed, it cycles through the following images: <ul style="list-style-type: none"> • USB Display • Images from the device connected to the USB(TypeA) port |
| 10 [Volume] buttons [Left] [Right] | [Left] Decreases the volume. [Right] Increases the volume. ☛ "Adjusting the Volume" p.41 |

Using the Mail Notification Function to Report Problems

When you set Mail Notification, notification messages are sent to the preset email addresses when a problem or warning occurs with a projector. This will enable the operator to be notified of problems with projectors even at locations away from the projectors.

 **Network - Mail - Mail Notification** p.96

- Up to a maximum of three notification destinations (addresses) can be registered, and notification messages can be sent to all three destinations at once.
- If a projector develops a critical problem and suddenly stops working, it may not be able to send a message notifying an operator of the problem.
- If you set **Standby Mode** to **Communication On**, you can control the projector even if it is in standby mode (when the power is off).

 **Extended - Standby Mode** p.91

Reading Error Notification Mail

When the Mail Notification function is set to On and a problem or warning occurs in the projector, the following email will be sent.

Mail sender: Address for Address 1

Subject: EPSON Projector

Line 1: The projector name where the problem has occurred

Line 2: The IP address set for the projector where the problem has occurred.

Line 3 and on: Details of the problem

The details of the problem are listed line by line. The main message contents are listed below.

- Internal error
- Fan related error
- Sensor error
- Lamp timer failure

- Lamp out
- Internal temperature error
- High-speed cooling in progress
- Lamp replacement notification
- No-signal
No Signal is input to the projector. Check the connection status or check that the power for the signal source is turned on.
- Auto Iris Error
- Power Err. (Ballast)

See the following to deal with problems or warnings.

 "Reading the Indicators" p.104

Management Using SNMP

By setting **SNMP** to **On** in the Configuration menu, notification messages are sent to the specified computer when a problem or warning occurs. This will enable the operator to be notified of problems with projectors even at locations away from the projectors.

 **Network - Others - SNMP** p.98

- SNMP should be managed by a network administrator or someone who is familiar with the network.
- To use the SNMP function to monitor the projector, you need to install the SNMP manager program on your computer.
- Up to two destination IP addresses can be saved.

ESC/VP21 Commands

You can control the projector from an external device using ESC/VP21.

Command list

When the power ON command is transmitted to the projector, the power turns on and it enters warm-up mode. When the projector's power has turned on, a colon ":" (3Ah) is returned.

When a command is input, the projector executes the command and returns a ":", and then accepts the next command.

If the command being processed terminates abnormally, an error message is output and a ":" is returned.

The main contents are listed below.

| Item | | Command | |
|------------------|-------------|-----------|-----------|
| Power ON/OFF | On | PWR ON | |
| | Off | PWR OFF | |
| Signal selection | Computer1 | Auto | SOURCE 1F |
| | | RGB | SOURCE 11 |
| | | Component | SOURCE 14 |
| | Computer2 | Auto | SOURCE 2F |
| | | RGB | SOURCE 21 |
| | | Component | SOURCE 24 |
| | HDMI | | SOURCE 30 |
| | Video | | SOURCE 41 |
| | USB Display | | SOURCE 51 |
| | USB | | SOURCE 52 |
| | LAN | | SOURCE 53 |
| DisplayPort | | SOURCE 70 | |

| Item | | Command |
|-----------------|-----|----------|
| A/V Mute On/Off | On | MUTE ON |
| | Off | MUTE OFF |

Add a Carriage Return (CR) code (0Dh) to the end of each command and transmit.

For more details, contact your local dealer or the nearest address provided in the Epson Projector Contact List.

 [Epson Projector Contact List](#)

Cable layouts

Serial connection

- Connector shape: D-Sub 9-pin (male)

- Projector input port name: RS-232C

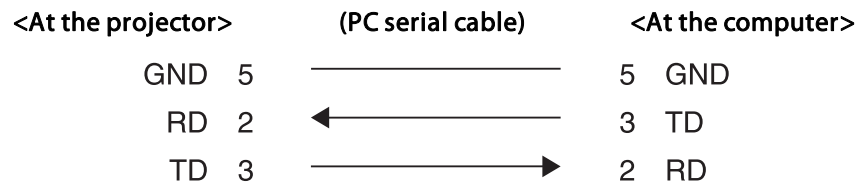
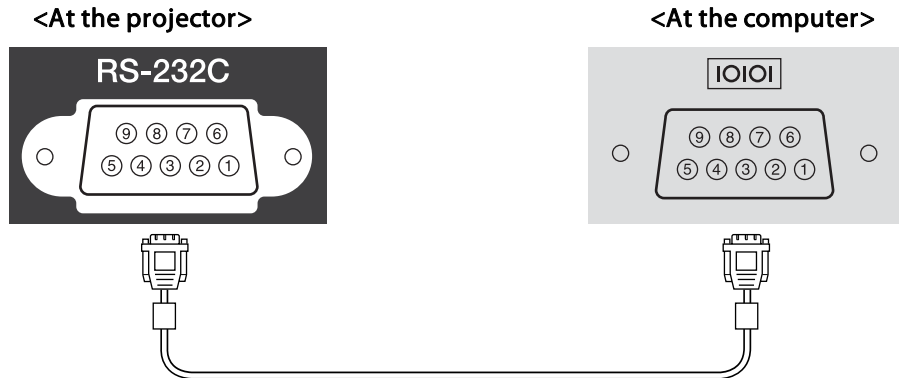

| Signal Name | Function |
|-------------|--------------------|
| GND | Signal wire ground |
| TD | Transmit data |
| RD | Receive data |

Communications protocol

- Default baud rate setting: 9600 bps
- Data length: 8 bit
- Parity: None
- Stop-bit: 1 bit
- Flow control: None

About PJLink

PJLink Class1 was established by the JBMIA (Japan Business Machine and Information System Industries Association) as a standard protocol for controlling network-compatible projector's as part of their efforts to standardize projector control protocols.

The projector complies with the PJLink Class1 standard established by the JBMIA.

You need to make network settings before you can use PJLink. See the following for more information on network settings.

☛ "Network Menu" [p.93](#)

It complies with all commands except for the following commands defined by PJLink Class1, and agreement was confirmed by the PJLink standard adaptability verification.

URL:<http://pjlink.jbmia.or.jp/english/>

- **Non-compatible commands**

| | Function | PJLink Command |
|----------------------|------------------|----------------|
| Mute settings | Image muting set | AVMT 11 |
| | Audio muting set | AVMT 21 |

- **Input names defined by PJLink and corresponding projector sources**

| Source | PJLink Command |
|--------------------|----------------|
| Computer1 | INPT 11 |
| Computer2 | INPT 12 |
| Video | INPT 21 |
| HDMI | INPT 32 |
| DisplayPort | INPT 35 |
| USB | INPT 41 |

| Source | PJLink Command |
|-------------|----------------|
| LAN | INPT 52 |
| USB Display | INPT 53 |

- Manufacturer name displayed for "Manufacture name information query"
EPSON
- Model name displayed for "Product name information query"
EB-1960/EB-C760X/PowerLite 1960
EB-1950/EB-C750X/PowerLite 1950
EB-1940W/EB-C740W/PowerLite 1940W
EB-1930/EB-C740X/PowerLite 1930

About Crestron RoomView®

Crestron RoomView® is an integrated control system provided by Crestron®. It can be used to monitor and control multiple devices connected on a network.

The projector supports the control protocol, and can therefore be used in a system built with Crestron RoomView®.

Visit the Crestron® Web site for details on Crestron RoomView®. (Only English-language displays are supported.)

<http://www.crestron.com>

The following provides an overview of Crestron RoomView®.

- **Remote operation using a Web browser**
You can operate a projector from your computer just like using a remote control.

• Monitoring and control with application software

You can use Crestron RoomView® Express or Crestron RoomView® Server Edition provided by Crestron® to monitor devices in the system, to communicate with the help desk, and to send emergency messages. See the following Web site for details.

<http://www.crestron.com/getroomview>

This manual describes how to perform operations on your computer using a Web browser.



- You can only enter single-byte alphanumeric characters and symbols.
- The following functions cannot be used while using Crestron RoomView®.
 - ☛ "Changing Settings Using a Web Browser (Web Control)"
p.74
 - Message Broadcasting (EasyMP Monitor plug-in)
- If you set **Standby Mode** to **Communication On**, you can control the projector even if it is in standby mode (when the power is off).
 - ☛ **Extended - Standby Mode** p.91

Operating a projector from your computer

Displaying the operation window

Check the following before carrying out any operations.

- Make sure the computer and projector are connected to the network.
- Set **Crestron RoomView** to **On** from the **Network** menu.
 - ☛ **Network - Others - Crestron RoomView** p.98

- 1 Start the Web browser on the computer.

- Enter the IP address of the projector in the address field of the Web browser, and press the Enter key on the keyboard.
The operation window is displayed.

Using the operation window

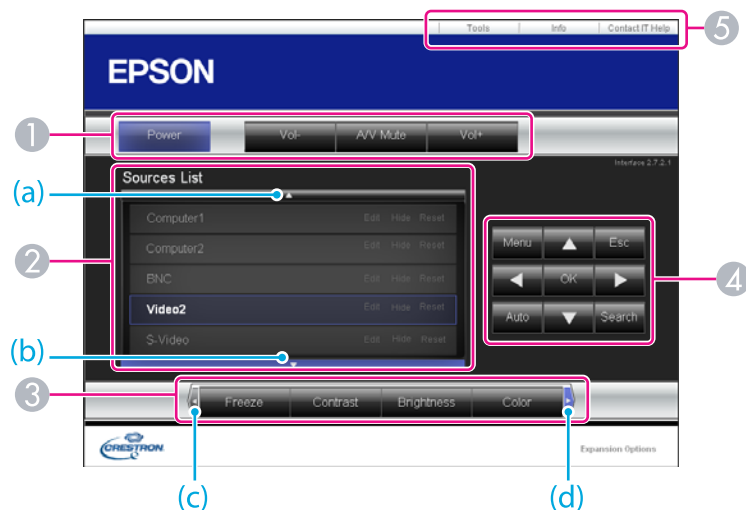

- You can perform the following operations when you click the buttons.

| Button | Function |
|------------------|--------------------------------------|
| Power | Turns the projector power on or off. |
| Vol-/Vol+ | Adjusts the volume. |

| Button | Function |
|-----------------|--|
| A/V Mute | Turns the video and audio on or off. ☛ "Hiding the Image and Sound Temporarily (A/V Mute)" p.61 |

- Switch to the image from the selected input source. To display input sources that are not shown in Source List, click (a) or (b) to scroll up or down. The current video signal input source is displayed in blue.
You can change the source name if necessary.
- You can perform the following operations when you click the buttons. To display buttons that are not shown in Source List, click (c) or (d) to scroll left or right.

| Button | Function |
|-------------------|---|
| Freeze | Images are paused or unpaused. ☛ "Freezing the Image (Freeze)" p.61 |
| Contrast | Adjusts the difference between light and shade in the images. |
| Brightness | Adjusts the image brightness. |
| Color | Adjusts the color saturation for the images. |
| Sharpness | Adjusts the image sharpness. |
| Zoom | Click the [⊕] button to enlarge the image without changing the projection size. Click the [⊖] button to reduce an image that was enlarged with the [⊕] button. Click the [▲], [▼], [◀], or [▶] button to change the position of an enlarged image. ☛ "Enlarging Part of the Image (E-Zoom)" p.63 |

- The [▲], [▼], [◀], and [▶] buttons perform the same operations as the [⊕], [⊖], [◂], [◃], [◄], and [◅] buttons on the remote control. You can perform the following operations when you click the other buttons.

| Button | Function |
|---------------|---|
| OK | Performs the same operation as the [↵] button on the remote control. ☛ "Remote Control" p.15 |
| Menu | Displays and closes the Configuration menu. |
| Auto | If clicked while projecting analog RGB signals from Computer1 port or Computer2 port, automatically optimizes the image by adjusting the Tracking, Sync., and Position. |
| Search | Changes to the next input source that is sending an image. ☛ "Automatically Detect Input Signals and Change the Projected Image (Source Search)" p.31 |
| Esc | Performs the same operation as the [Esc] button on the remote control. ☛ "Remote Control" p.15 |

5 You can perform the following operations when you click the tabs.

| Tab | Function |
|------------------------|---|
| Contact IT Help | Displays the Help Desk window. Used to send messages to, and receive messages from, the administrator using Crestron RoomView® Express. |
| Info | Displays information on the projector that is currently connected. |
| Tools | Changes settings in the projector that is currently connected. See the next section. |

Using the tools window

The following window is displayed when you click the **Tools** tab on the operation window. You can use this window to change settings in the projector that is currently connected.

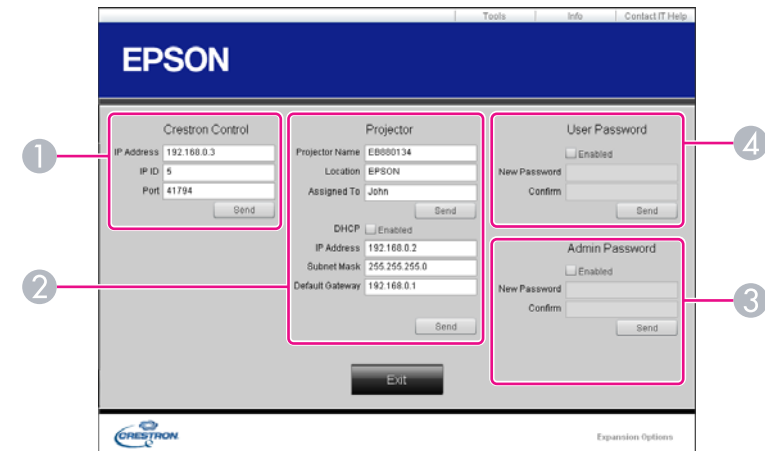

- 1 **Crestron Control**
Make settings for Crestron® central controllers.
- 2 **Projector**
The following items can be set.

| Item | Function |
|-----------------------|--|
| Projector Name | Enter a name to differentiate the projector that is currently connected from other projectors on the network. (The name can contain up to 15 single-byte alphanumeric characters.) |
| Location | Enter an installation location name for the projector that is currently connected on the network. (The name can contain up to 32 single-byte alphanumeric characters and symbols.) |
| Assigned To | Enter a user name for the projector. (The name can contain up to 32 single-byte alphanumeric characters and symbols.) |

| Item | Function |
|------------------------|---|
| DHCP | Select the Enabled check box to use DHCP. You cannot enter an IP address if DHCP is enabled. |
| IP Address | Enter the IP address to assign to the currently connected projector. |
| Subnet Mask | Enter a subnet mask for the currently connected projector. |
| Default Gateway | Enter the gateway address for the currently connected projector. |
| Send | Click this button to confirm the changes made to the Projector . |

| Item | Function |
|---------------------|--|
| New Password | Enter the new password when changing the password to open the operation window. (The name can contain up to 26 single-byte alphanumeric characters.) |
| Confirm | Enter the same password as you entered in New Password . If the passwords are not the same, an error is displayed. |
| Send | Click this button to confirm the changes made to the User Password . |

3 Admin Password

Select the **Enabled** check box to require a password to open the Tools window. The following items can be set.

| Item | Function |
|---------------------|--|
| New Password | Enter the new password when changing the password to open the Tools window. (The name can contain up to 26 single-byte alphanumeric characters.) |
| Confirm | Enter the same password as you entered in New Password . If the passwords are not the same, an error is displayed. |
| Send | Click this button to confirm the changes made to the Admin Password . |

4 User Password

Select the **Enabled** check box to require a password to open the operation window on the computer. The following items can be set.



Configuration Menu

This chapter explains how to use the Configuration menu and its functions.

This section explains how to use the Configuration menu.

Although steps are explained using the remote control as an example, you can perform the same operations from the control panel. Check the guide under the menu for the available buttons and their operations.

1 Display the Configuration menu screen.

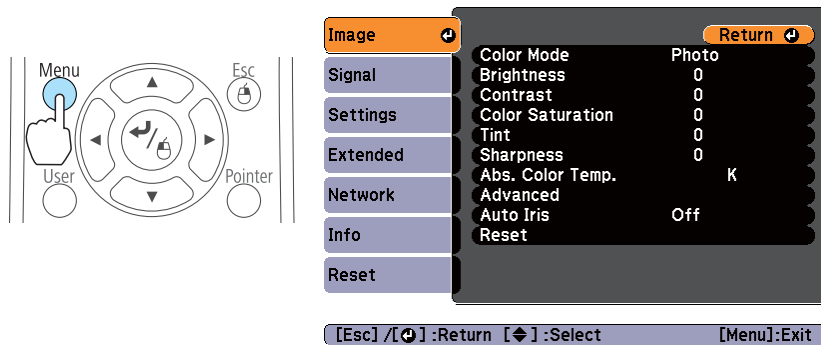

2 Select a top menu item.

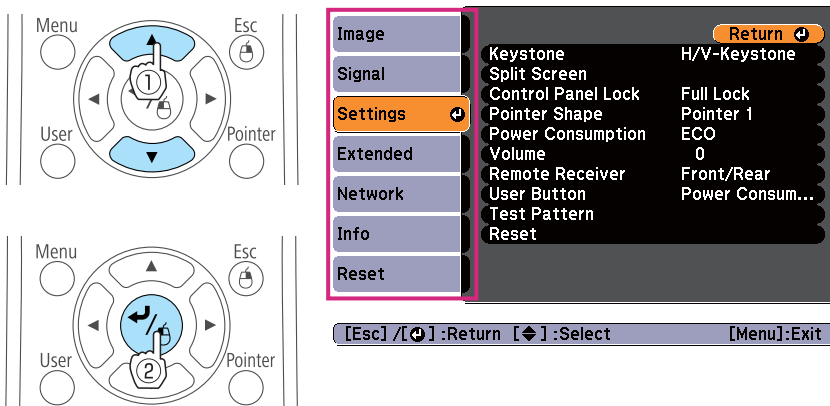

3 Select a submenu item.

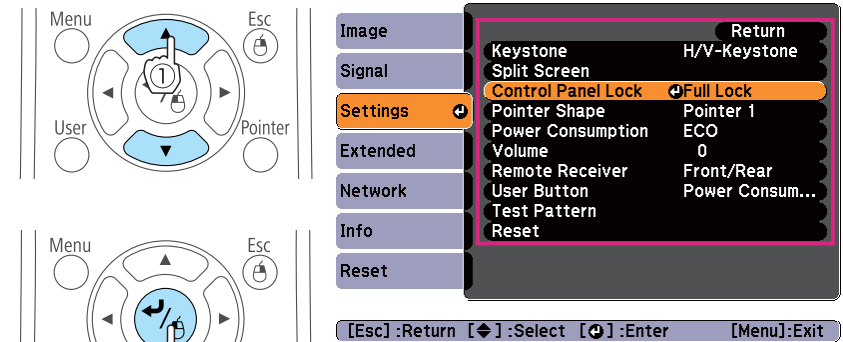

4 Change settings.

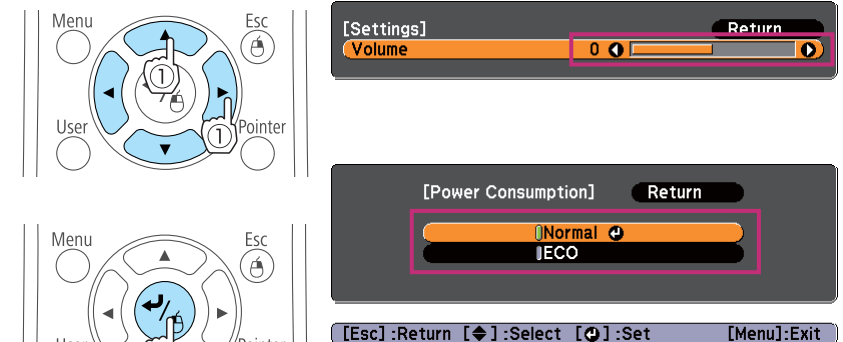

5 Press the [Menu] button to finish making settings.

Configuration Menu Table

Settable items vary depending on the model being used and the image signal and source being projected.

| Top Menu Name | Submenu Name | Items or Setting Values |
|-----------------------|--------------------------|--|
| Image menu ☛ p.87 | Color Mode | Dynamic, Presentation, Theatre, Photo, Sports, sRGB, Blackboard, Whiteboard, and DICOM SIM |
| | Brightness | -24 to 24 |
| | Contrast | -24 to 24 |
| | Color Saturation | -32 to 32 |
| | Tint | -32 to 32 |
| | Sharpness | -5 to 5 |
| | Abs. Color Temp. | 5000K to 10000K |
| | Advanced | Gamma, RGB, and RGBCMY |
| | Auto Iris | On and Off |
| Signal menu ☛ p.88 | Auto Setup | On and Off |
| | Resolution | Auto, Wide, and Normal |
| | Tracking | - |
| | Sync. | - |
| | Position | Up, Down, Left, and Right |
| | Progressive | Off, Video, and Film/Auto |
| | Noise Reduction | Off, NR1, and NR2 |
| | HDMI Video Range | Auto, Normal, and Expanded |
| | DisplayPort Video Range | Auto, Normal, and Expanded |
| Input Signal | Auto, RGB, and Component | |

| Top Menu Name | Submenu Name | Items or Setting Values |
|-------------------------|--------------------|--|
| | Video Signal | Auto, NTSC, NTSC4.43, PAL, M-PAL, N-PAL, PAL60, and SECAM |
| | Aspect | Normal, Auto, 4:3, 16:9, Full, Zoom, and Native |
| | Overscan | Auto, Off, 4%, and 8% |
| | Image Processing | Fast, Fine |
| Settings menu ☛ p.90 | Keystone | H/V-Keystone and Quick Corner |
| | Split Screen | - |
| | Control Panel Lock | Full Lock, Partial Lock, and Off |
| | Pointer Shape | Pointer 1, 2, and 3 |
| | Power Consumption | Normal and ECO |
| | Volume | 0 to 20 |
| | Remote Receiver | Front/Rear, Front, Rear, and Off |
| | User Button | Power Consumption, Info, Progressive, Test Pattern, Multi-screen, and Resolution |
| Extended menu ☛ p.91 | Test Pattern | - |
| | Display | Messages, Display Background, Startup Screen, and A/V Mute |
| | User's Logo | - |
| | Projection | Front, Front/Ceiling, Rear, and Rear/Ceiling |
| | Operation | Direct Power On, Sleep Mode, Sleep Mode Timer, Lens Cover Timer, High Altitude Mode, and Audio Input |
| | Standby Mode | Communication On and Communication Off |
| | Projector ID | Off, or 1 to 9 |

| Top Menu Name | Submenu Name | Items or Setting Values |
|-----------------------|------------------|---|
| | Multi-screen | Adjustment Level, Brightness Correct., Color Correct. (G/R), and Color Correct. (B/Y) |
| | Language | 15 or 35 languages* ¹ |
| Info menu ☛ p.99 | Lamp Hours | - |
| | Source | - |
| | Input Signal | - |
| | Resolution | - |
| | Video Signal | - |
| | Refresh Rate | - |
| | Sync Info | - |
| | Status | - |
| | Serial Number | - |
| | Event ID | - |
| Reset menu ☛ p.100 | Reset All | - |
| | Reset Lamp Hours | - |

*1 The number of supported languages differs depending on the region where the projector is used.

Network menu

| Top Menu Name | Submenu Name | Items or Setting Values |
|--------------------------|----------------------|--|
| Basic menu ☛ p.95 | Projector Name | - |
| | PJLink Password | - |
| | Web Control Password | - |
| | Projector Keyword | On and Off |
| Wired LAN menu ☛ p.96 | IP Settings | DHCP, IP Address, Subnet Mask, and Gateway Address |

| Top Menu Name | Submenu Name | Items or Setting Values |
|-----------------------|---|-------------------------|
| | IP Address Display | On and Off |
| Mail menu ☛ p.96 | Mail Notification | On and Off |
| | SMTP Server | - |
| | Port Number | - |
| | Address 1 Setting, Address 2 Setting, and Address 3 Setting | - |
| Others menu ☛ p.98 | SNMP | On and Off |
| | Trap IP Address 1 and Trap IP Address 2 | - |
| | AMX Device Discovery | On and Off |
| | Crestron RoomView | On and Off |
| | Bonjour | On and Off |
| | Message Broadcasting | On and Off |

Image Menu

Settable items vary depending on the image signal and source currently being projected. Setting details are saved for each image signal.

☛ "Automatically Detect Input Signals and Change the Projected Image (Source Search)" [p.31](#)

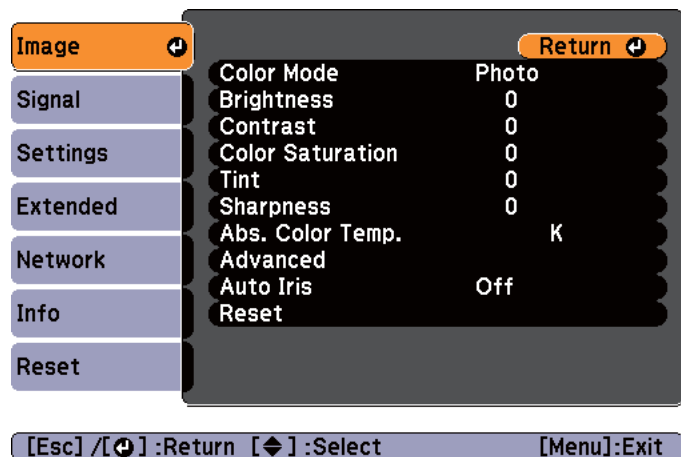

| Submenu | Function |
|-------------------------|---|
| Color Mode | You can select the quality of the image to suit your surroundings. ☛ "Selecting the Projection Quality (Selecting Color Mode)" p.43 |
| Brightness | You can adjust the image brightness. |
| Contrast | You can adjust the difference between light and dark in the images. |
| Color Saturation | (Adjustment is only possible when component video or composite video images are being input.) You can adjust the color saturation for the images. |
| Tint | (Adjustment is possible when a component video signal is being input. If a composite video signal is input, adjustment is only possible when NTSC signals are being input.) You can adjust the image tint. |
| Sharpness | You can adjust the image sharpness. |

| Submenu | Function |
|-------------------------|---|
| Abs. Color Temp. | You can adjust the overall tint of the image. You can adjust tints in 10 stages from 5000 K to 10000 K. The image is tinted blue when a high value is selected and tinted red when a low value is selected. |
| Advanced | You can make adjustments by choosing the following items. Gamma: You can adjust the coloring by selecting one of the gamma correction values, or referring to the projected image or a gamma graph. RGB: You can adjust the individual R (red), G (green), and B (blue) components of the offset and gain. RGBCMY: You can adjust the hue, saturation, and brightness of each color R (red), G (green), B (blue), C (cyan), M (magenta), Y (yellow) individually. |
| Auto Iris | (This item can be set only if Color Mode is set to Dynamic or Theatre .) Set to On to adjust the iris to obtain the optimum light for images being projected. The setting is stored for each Color Mode. ☛ "Setting Auto Iris" p.44 |
| Reset | You can reset all adjustment values for the Image menu to their default settings. See the following to return all menu items to their default settings. ☛ "Reset Menu" p.100 |

Signal Menu

Settable items vary depending on the image signal and source currently being projected. Setting details are saved for each image signal.

You cannot make settings on the Signal menu when the source is USB Display, USB, or LAN.

☛ "Automatically Detect Input Signals and Change the Projected Image (Source Search)" p.31

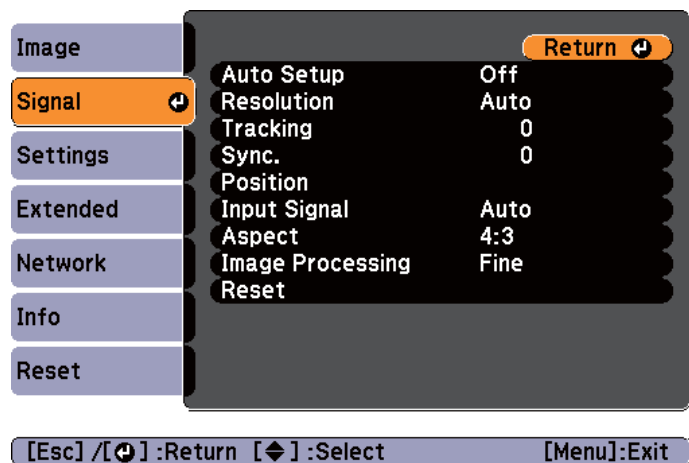

| Submenu | Function |
|-------------------|--|
| Auto Setup | (Only available when an analog RGB computer signal is being input.) Set to On to automatically adjust Tracking, Sync., and Position to the optimum state when the input signal changes. |
| Resolution | (Only available when an analog RGB computer signal is being input.) Set to Auto to automatically identify the resolution of the input signal. If images are not projected correctly when set to Auto , for example if some of the image is missing, adjust to Wide for wide screens, or set to Normal for 4:3 or 5:4 screens depending on the connected computer. |
| Tracking | (Only available when an analog RGB computer signal is being input.) You can adjust computer images when vertical stripes appear in the images. |



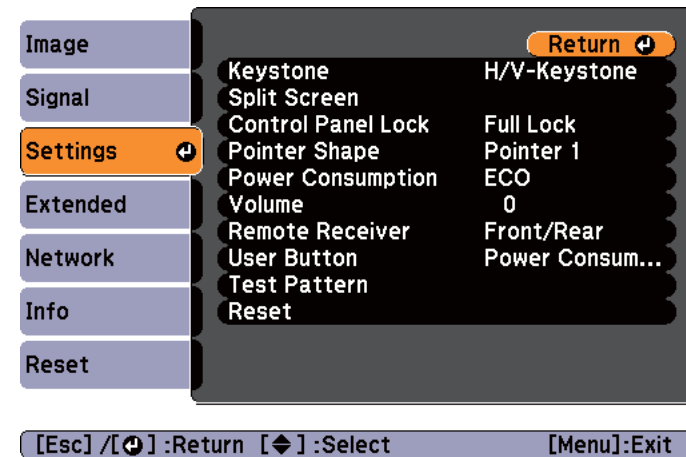

| Submenu | Function |
|--------------------------------|--|
| Sync. | (Only available when an analog RGB computer signal is being input.) You can adjust computer images when flickering, fuzziness, or interference appear in the images. |
| Position | (This item cannot be set when the source is HDMI or DisplayPort.) You can adjust the display position up, down, left, and right when a part of the image is missing so that the whole image is projected. |
| Progressive | (This setting can only be adjusted when a composite video signal is being input. When a component video or RGB video is being input, this setting can only be adjusted if the signal being input is an interlaced signal (480i/576i/1080i.) <u>Interlace</u> (i) signal is converted to <u>Progressive</u> (p). (IP conversion) Off: Ideal for images with a large amount of movement. Video: Ideal for general video images. Film/Auto: This is ideal for movie films, computer graphics, and animation. |
| Noise Reduction | (This cannot be set when a digital RGB signal is input, when projecting an interlaced signal while Progressive is set to Off , or when a 480p, 576p, or 1080p signal is input while Image Processing is set to Fast .) Smooths out rough images. There are two modes. Select your favorite setting. It is recommended that this is set to Off when viewing image sources in which noise is very low, such as for DVDs. |
| HDMI Video Range | When the projector's HDMI port is connected to a DVD player, set the projector's video range according to the DVD player's video range setting. |
| DisplayPort Video Range | When the projector's DisplayPort port is connected to a computer, set the projector's video range according to the computer's video range setting. |

| Submenu | Function |
|-------------------------|--|
| Input Signal | You can select input signal from Computer port. If set to Auto , the input signal is set automatically according to the connected equipment. If colors do not appear correctly when set to Auto , select the appropriate signal according to the connected equipment. |
| Video Signal | You can select the input signal from the Video port. If set to Auto , video signals are recognized automatically. If interference appears in the image or a problem occurs such as no image is being projected when set to Auto , select the appropriate signal according to the connected equipment. |
| Aspect | You can set the <u>aspect ratio</u> for projected images. ☛ "Changing the Aspect Ratio of the Projected Image " p.44 |
| Overscan | (This setting can only be adjusted when a component video or RGB video signal is being input.) Changes the output image ratio (the range of the projected image). You can set the cropping range to Off , 4% , or 8% . When the source is HDMI, Auto is available. When Auto is selected, it automatically changes to Off or 8% according to the input signal. |
| Image Processing | Changes settings for image processing. Fast: Images are displayed quicker. The pen's tracking delay is improved when using the optional interactive unit. Fine: Images are displayed in higher quality. |
| Reset | You can reset all adjustment values on the Signal menu to their default settings, except for Input Signal . See the following to return all menu items to their default settings. ☛ "Reset Menu" p.100 |

Settings Menu



| Submenu | Function |
|---------------------------|---|
| Keystone | You can correct keystone distortion. <ul style="list-style-type: none"> When H/V-Keystone is selected: Adjust V-Keystone and H-Keystone to correct horizontal and vertical keystone distortion. You can also set H-Keystone Adjuster and Auto V-Keystone to On or Off. ☛ "Correcting Keystone Distortion" p.36 When Quick Corner is selected: Select and correct the four corners of the projected image. ☛ "Quick Corner" p.38 |
| Split Screen | You can split the screen into two screens. You can change the Screen Size, and select the Source, Swap Screens, Audio Source, and Exit Split Screen. ☛ "Projecting Two Images Simultaneously (Split Screen)" p.49 |
| Control Panel Lock | You can use this to restrict operation of the projector's control panel. ☛ "Restricting Operation (Control Panel Lock)" p.72 |

| Submenu | Function |
|--------------------------|--|
| Pointer Shape | <p>You can select the shape of the pointer.</p> <p>Pointer 1: </p> <p>Pointer 2: </p> <p>Pointer 3: </p> <p> "Pointer Function (Pointer)" p.62</p> |
| Power Consumption | <p>You can set the lamp brightness to one of two settings. Select ECO if the images being projected are too bright, such as when projecting images in a dark room or onto a small screen. When ECO is selected, the power consumption and the lamp's operating life are changed as follows, and fan rotation noise during projection is reduced.</p> <p>Electrical consumption: about 25% decrease, lamp life: about 1.4 times longer</p> |
| Volume | <p>You can adjust the volume. Setting values are saved for each source.</p> |
| Remote Receiver | <p>You can limit the reception of the operation signal from the remote control.</p> <p>When set to Off, you cannot perform any operations from the remote control. If you want to make operations from the remote control, hold down the [Menu] button on the remote control for at least 15 seconds to reset the setting to its default value.</p> |
| User Button | <p>You can select and assign an item from the Configuration menu with the remote control's [User] button. Pressing the [User] button directly displays the assigned menu item selection/adjustment screen, allowing you to make one-touch changes to settings/adjustments. You can assign one of the following items to the [User] button.</p> <p>Power Consumption, Info, Progressive, Test Pattern, Multi-screen, and Resolution</p> |

| Submenu | Function |
|---------------------|--|
| Test Pattern | <p>You can display a test pattern to adjust the projection without connecting other equipment when you set up the projector. While the test pattern is displayed, zoom, focus adjustments, and keystone correction can be performed. To cancel the test pattern, press the [Esc] button on the remote control or the control panel.</p> <div style="border: 1px solid black; padding: 5px; margin-top: 10px;"> <p>Attention</p> <p>If a pattern is displayed for a long time, a residual image may be visible in projected images.</p> </div> |
| Reset | <p>You can reset all adjustment values on the Settings menu to their default settings, except for User Button.</p> <p>See the following to return all menu items to their default settings.</p> <p> "Reset Menu" p.100</p> |

Extended Menu

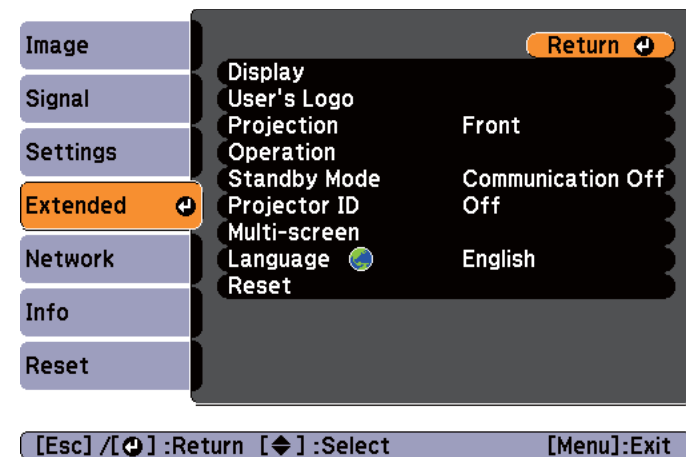

| Submenu | Function |
|-----------------------|---|
| Display | <p>You can make settings related to the projector's display.</p> <p>Messages: When set to Off, the following items will not be displayed.</p> <p>Item names when the Source, Color Mode, or Aspect Ratio is changed, messages when no signal is being input, and warnings such as High Temp Warning.</p> <p>Display Background*1: You can set the screen background to Black, Blue, or Logo when no image signal is available.</p> <p>Startup Screen*1: Set to On to display the User's Logo when projection starts.</p> <p>A/V Mute*1: You can set the screen displayed when the remote control's [A/V Mute] button is pressed to Black, Blue, or Logo.</p> |
| User's Logo *1 | <p>You can change the user's logo that is displayed as a background during Display Background, A/V Mute, and so on.</p> <p>☛ "Saving a User's Logo" p.68</p> |
| Projection | <p>Select from one of the following projection methods depending on how the projector is installed.</p> <p>Front, Front/Ceiling, Rear, and Rear/Ceiling</p> <p>You can change the setting as follows by pressing down the [A/V Mute] button on the remote control for about five seconds.</p> <p>Front ↔ Front/Ceiling</p> <p>Rear ↔ Rear/Ceiling</p> <p>☛ "Installation Methods" p.20</p> |

| Submenu | Function |
|---------------------|---|
| Operation | <p>Direct Power On: Set to On to turn on the projector simply by plugging it in.</p> <p>When the power cord is plugged in, note that the projector turns on automatically in cases such as a power outage being restored.</p> <p>Sleep Mode: When set to On, this automatically stops projection when no image signal is being input and no operations are carried out.</p> <p>Sleep Mode Timer: When Sleep Mode is set to On, you can set the time before the projector automatically turns off within a range of 1 to 30 minutes.</p> <p>Lens Cover Timer: When set to On, this turns off the power automatically 30 minutes after the A/V mute slide is closed.</p> <p>The default value is On.</p> <p>High Altitude Mode: Set to On when using the projector above an altitude of 1500 m.</p> <p>Audio Input: When set to Auto, the audio from the input source is output.</p> <p>When set to Audio1, Audio2, or Audio (L/R), audio is output from the selected port regardless of the input source as long as audio is input from the audio input port.</p> |
| Standby Mode | <p>If you set Communication On, you can perform the following operations even if the projector is in standby mode.</p> <ul style="list-style-type: none"> Monitoring and controlling the projector over a network <ul style="list-style-type: none"> ☛ "Monitoring and Controlling" p.74 Outputting analog RGB signals from the Computer1 port to an external monitor |
| Projector ID | <p>Set the ID to a number between 1 and 9. Off indicates that no ID is set.</p> <p>☛ "Setting the projector ID" p.66</p> |

| Submenu | Function |
|---------------------|---|
| Multi-screen | You can adjust the hue and brightness of each projected image when multiple projectors are lined up and projecting. Adjustment Level: You can adjust from black to white in five stages called Level 1 to 5, and in each of these 5 levels, you can adjust Brightness Correct. and Color Correct. Brightness Correct.: You can correct the difference in the brightness of each projector. Color Correct. (G/R) / Color Correct. (B/Y): You can correct the difference in the color of each projector. ☛ "Correcting the Color Difference when Projecting from Multiple Projectors" p.65 |
| Language | You can set the language for messages and menus. |
| Reset | You can reset the adjustment values for Display *1 and Operation *2 from the Extended menu to their default settings. See the following to return all menu items to their default settings. ☛ "Reset Menu" p.100 |

*1 When **User's Logo Protect** is set to **On** in **Password Protect**, settings related to user's logo cannot be changed. You can make changes after setting **User's Logo Protect** to **Off**.

☛ "Managing Users (Password Protect)" [p.70](#)

*2 Except for High Altitude Mode.

Network Menu

When **Network Protect** is set to **On** in **Password Protect**, a message is displayed and the network settings cannot be changed. Set **Network Protect** to **Off** and then configure the network.

☛ "Setting Password Protect" [p.70](#)

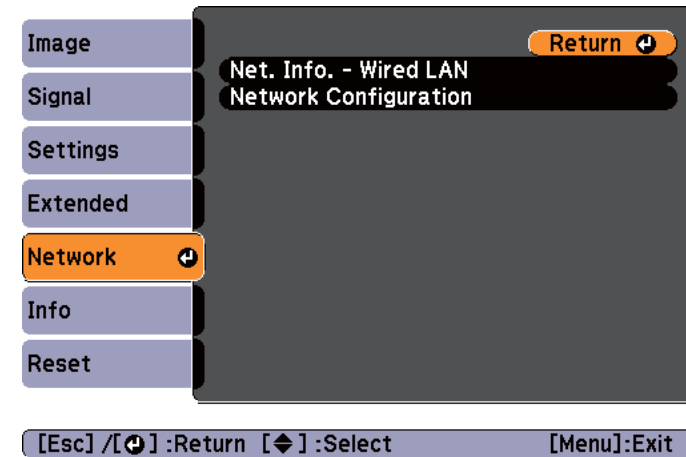

| Submenu | Function |
|-------------------------------|--|
| Net. Info. - Wired LAN | Displays the following network setting status information. <ul style="list-style-type: none"> • Projector Name • DHCP • IP Address • Subnet Mask • Gateway Address • MAC Address |
| Network Configuration | The following menus are available for setting Network items. Basic, Wired LAN, Mail, Others, and Reset |



By using a Web browser of a computer connected to the projector on a network, you can set functions and control the projector. This function is called Web Control. You can easily enter text using a keyboard to make settings for Web Control such as Security settings.

☛ "Changing Settings Using a Web Browser (Web Control)" [p.74](#)

Notes on operating the Network menu

Selecting from the top menu and sub menus, and changing selected items is the same as making operations from the Configuration menu.

When done, make sure you go to the **Complete** menu, and select **Yes**, **No**, or **Cancel**. When you select **Yes** or **No**, you are returned to the Configuration menu.



Yes: Saves the settings and exits the Network menu.

No: Does not save the settings and exits the Network menu.

Cancel: Continues displaying the Network menu.

Soft keyboard operations

The Network menu contains items that require input of alphanumerics during setup. In this case, the following software keyboard is displayed. Use the [Left], [Right], [Up], and [Down] buttons on the remote control or the [Left], [Right], [Up], and [Down] buttons on the control panel to move the cursor to the desired key, and then press the [Enter] button to enter the alphanumeric character. Enter figures by holding down the [Num] button on the remote control, and pressing the numeric buttons. After inputting, press **Finish** on the keyboard to confirm your input. Press **Cancel** on the keyboard to cancel your input.

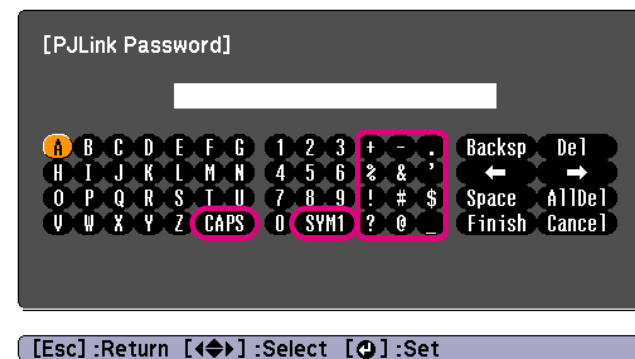

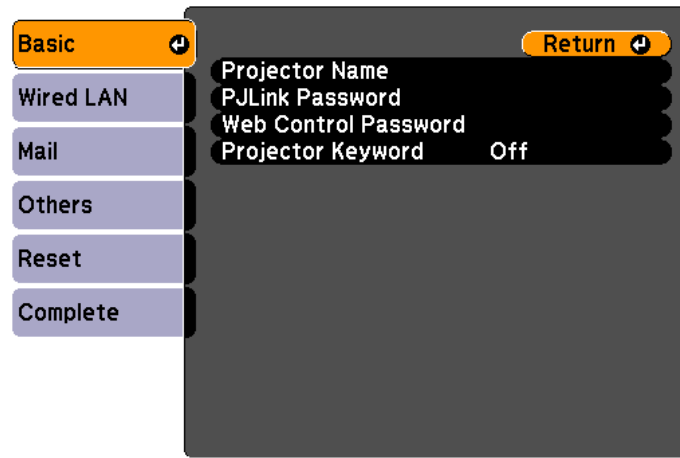

- Each time the **CAPS** key is selected and the [Enter] button is pressed, it sets and changes between upper case and lower case letters.
- Each time the **SYM1/2** key is selected and the [Enter] button is pressed, it sets and changes the symbol keys for the section enclosed by the frame.

Basic menu



[Esc] / [F4] :Return [Enter] :Select

| Submenu | Function |
|-------------------|--|
| Projector Keyword | <p>When set to On, you have to enter the keyword when you try to connect the projector to a computer via a network. As a result, you can prevent presentations from being interrupted by connections from other computers. Normally this should be set to On.</p> <p> EasyMP Network Projection Operation Guide</p> |

| Submenu | Function |
|-----------------------------|--|
| Projector Name | <p>Displays the projector name used to identify the projector when connected to a network.</p> <p>When editing, you can enter up to 16 single-byte alphanumeric characters.</p> |
| PJLink Password | <p>Set a password to use when you access the projector using compatible PJLink software.</p> <p>You can enter up to 32 single-byte alphanumeric characters.</p> |
| Web Control Password | <p>Set a password to use when making settings and controlling the projector using Web Control. Enter no more than eight single-byte alphanumeric characters. Web Control is a computer function that allows you to set up and control the projector by using the Web browser on a computer connected on a network.</p> <p> "Changing Settings Using a Web Browser (Web Control)" p.74</p> |

Wired LAN menu

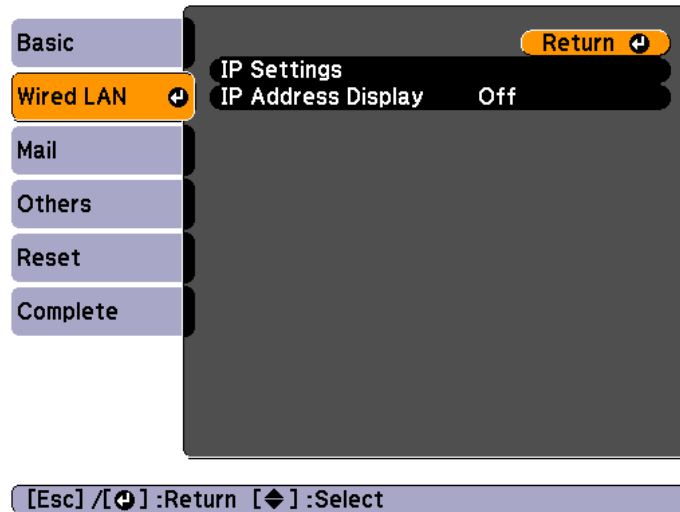

| Submenu | Function |
|--------------------|--|
| IP Settings | <p>You can make settings related to the following addresses.</p> <p>DHCP: Set to On to configure the network using DHCP. If this is set to On, you cannot set any more addresses.</p> <p>IP Address: You can input the IP address assigned to the projector. You can enter a number from 0 to 255 in each field of the address. However, the following IP addresses cannot be used. 0.0.0.0, 127.x.x.x, 224.0.0.0 to 255.255.255.255 (where x is a number from 0 to 255)</p> <p>Subnet Mask: You can input the subnet mask for the projector. You can enter a number from 0 to 255 in each field of the address. However, the following subnet masks cannot be used. 0.0.0.0, 255.255.255.255</p> <p>Gateway Address: You can input the IP address for the gateway for the projector. You can enter a number from 0 to 255 in each field of the address. However, the following gateway addresses cannot be used. 0.0.0.0, 127.x.x.x, 224.0.0.0 to 255.255.255.255 (where x is a number from 0 to 255)</p> |
| IP Address Display | <p>To prevent the IP address from being displayed on Network Info in the Network Menu and on the LAN Standby screen, set this to Off.</p> |

Mail menu

When this is set, you receive an email notification if a problem or warning occurs in the projector.

☛ "Using the Mail Notification Function to Report Problems" p.76

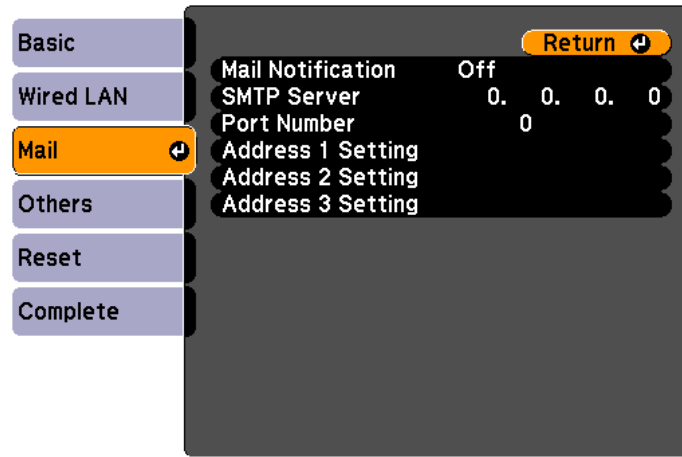

[Esc] / [Return] :Return [Enter] :Select

| Submenu | Function |
|--|---|
| Address 1 Setting/Address 2 Setting/Address 3 Setting | <p>You can input the email address of the destination to send the notification email to. You can register up to three destinations. You can enter up to 32 single-byte alphanumeric characters for the email addresses.</p> <p>The address for destination 1 is the mail notification sender's address.</p> <p>You can select the problems or warnings to be notified about by email. When the selected problem or warning occurs in the projector, an email is sent to the specified destination address notifying that a problem or warning has occurred. You can select multiple items from the displayed items.</p> |

| Submenu | Function |
|--------------------------|--|
| Mail Notification | Set to On to send an email to the preset addresses when a problem or warning occurs with a projector. |
| SMTP Server | <p>You can input the <u>IP address</u> for the SMTP server for the projector.</p> <p>You can enter a number from 0 to 255 in each field of the address. However, the following IP addresses cannot be used.</p> <p>127.x.x.x, 224.0.0.0 to 255.255.255.255 (where x is a number from 0 to 255)</p> |
| Port Number | You can input the port number for the SMTP server. The default value is 25. You can input numbers between 1 to 65535. |

Others menu

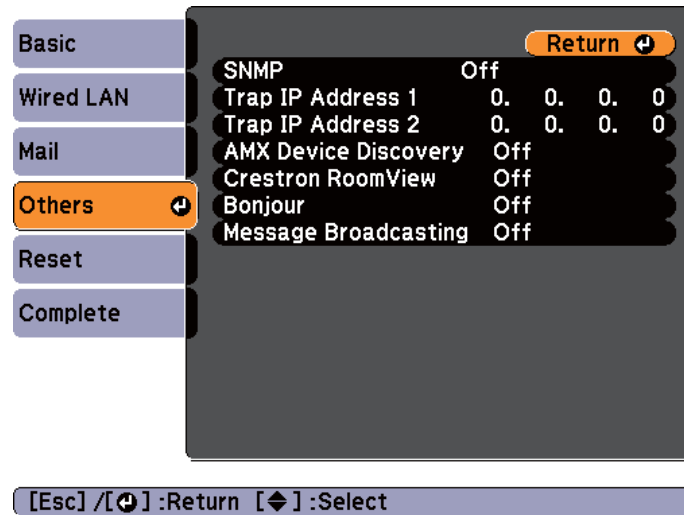

| Submenu | Function |
|-------------------------------------|--|
| SNMP | Set to On to monitor the projector using SNMP. To monitor the projector, you need to install the SNMP manager program on your computer. SNMP should be managed by a network administrator. The default value is Off . |
| Trap IP Address 1/Trap IP Address 2 | You can register up to two IP addresses for the SNMP trap notification destination. You can enter a number from 0 to 255 in each field of the address. However, the following IP addresses cannot be used. 127.x.x.x, 224.0.0.0 to 255.255.255.255 (where x is a number from 0 to 255) |
| AMX Device Discovery | When you want to allow the projector to be detected by <u>AMX Device Discovery</u> , set this to On . Set this to Off if you are not connected to an environment controlled by a controller from AMX or AMX Device Discovery. |

| Submenu | Function |
|----------------------|--|
| Crestron RoomView | Set this to On only when monitoring or controlling the projector over the network using Crestron RoomView®. Otherwise, set this to Off . ☞ "About Crestron RoomView®" p.80 When this is set to On , the following functions are not available. <ul style="list-style-type: none"> • Web control • Message Broadcasting (EasyMP Monitor Plug-in) |
| Bonjour | Set this to On when connecting to the network using Bonjour. See Apple's Web site for more information on the Bonjour service. http://www.apple.com/ |
| Message Broadcasting | You can switch the EPSON Message Broadcasting function to enable or disable. You can download Message Broadcasting and its Operation Guide from the following Web site. http://www.epson.com |

Reset menu

Resets all of the network settings.

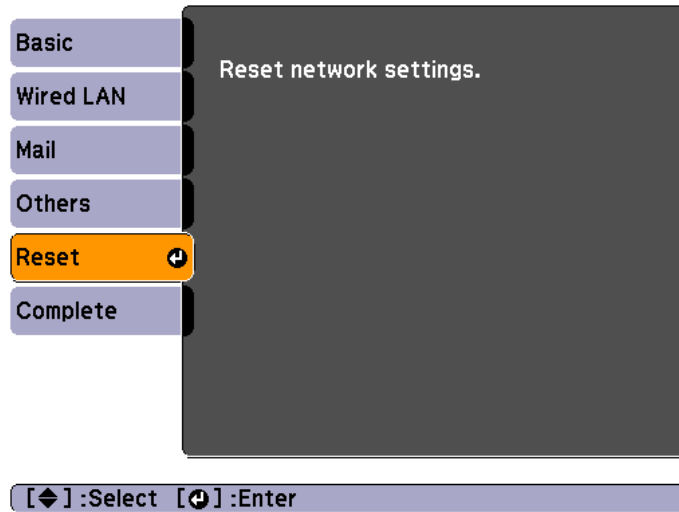

| Submenu | Function |
|-------------------------|---|
| Reset network settings. | To reset all of the Network settings, select Yes . |

Info Menu (Display Only)

Lets you check the status of the image signals being projected and the status of the projector. Items that can be displayed vary depending on the source currently being projected. Depending on the model used, some input sources are not supported.

"Automatically Detect Input Signals and Change the Projected Image (Source Search)" [p.31](#)

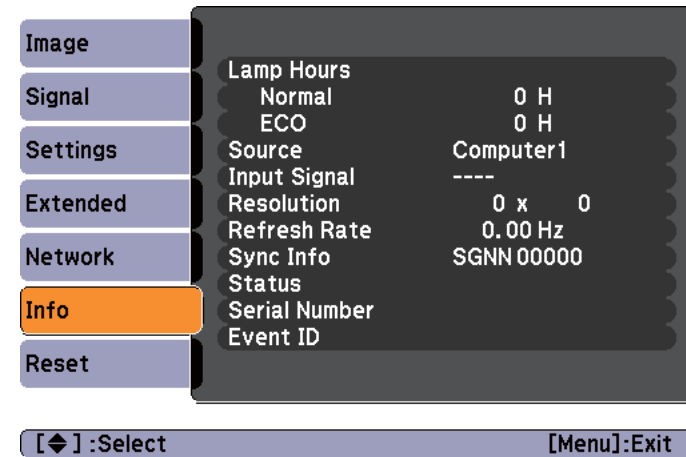

| Submenu | Function |
|---------------------|---|
| Lamp Hours | You can display the cumulative lamp operating time*. When the lamp replacement time is reached, the characters are displayed in yellow. |
| Source | You can display the source name for the connected equipment currently being projected. |
| Input Signal | You can display the content of Input Signal set in the Signal menu according to the source. |
| Resolution | You can display the resolution. |
| Video Signal | You can display the settings for Video Signal in the Signal menu. |
| Refresh Rate | You can display the <u>refresh rate</u> ▶. |
| Sync Info | You can display the image signal information. This information may be needed if service is required. |
| Status | This is information about errors that have occurred on the projector. This information may be needed if service is required. |

| Submenu | Function |
|---------------|---|
| Serial Number | Displays the projector's serial number. |
| Event ID | Displays the application error log. ☛ "About Event ID" p.117 |

* The cumulative use time is displayed as "0H" for the first 10 hours. 10 hours and above is displayed as "10H", "11H", and so on.

Reset Menu

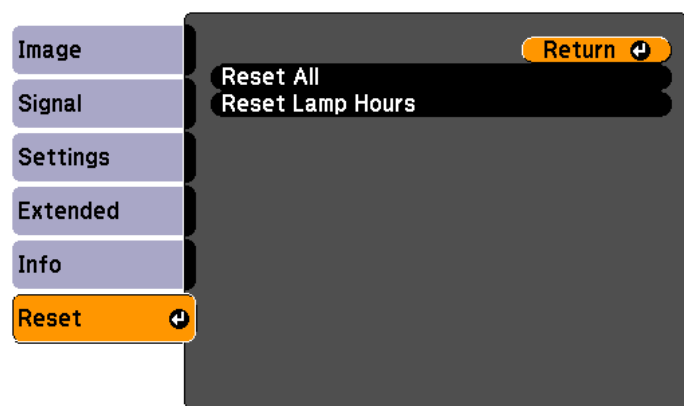

[Esc] / [Return] :Return [Enter] :Select [Menu]:Exit

| Submenu | Function |
|------------------|--|
| Reset All | You can reset all items in the Configuration menu to their default settings. The following items are not reset to their defaults: Input Signal , User's Logo , all items for Network menus, Lamp Hours , Language , Password , and User Button . |
| Reset Lamp Hours | Clears the cumulative lamp hours use time. Reset when you replace the lamp. |



Troubleshooting

This chapter explains how to identify problems and what to do if a problem is found.

If a problem occurs with the projector, the Help screen is displayed to assist you by pressing the Help button. You can solve problems by answering the questions.

- 1** Press the [Help] button.
The Help screen is displayed.

Using the remote control

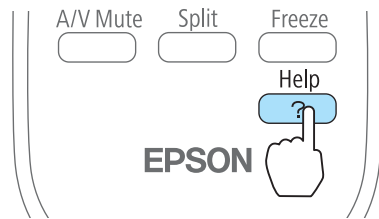

Using the control panel

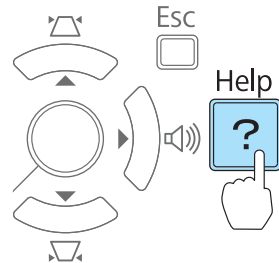

- 2** Select a menu item.

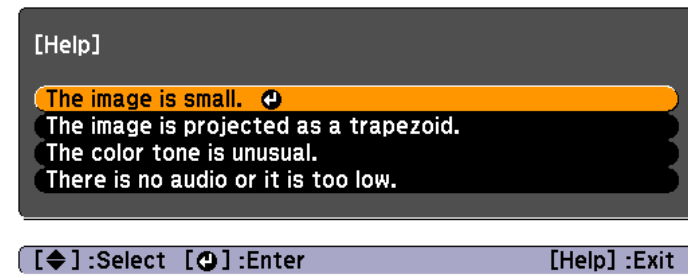

Using the remote control

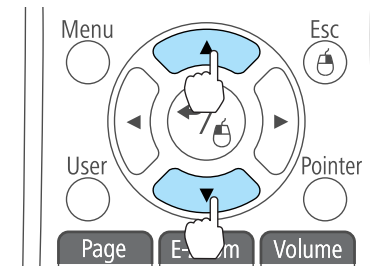

Using the control panel

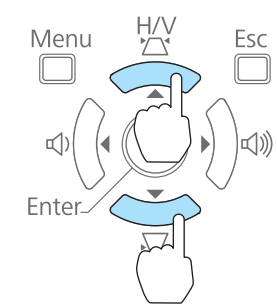

- 3** Confirm the selection.

Using the remote control

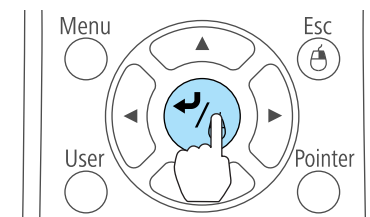

Using the control panel

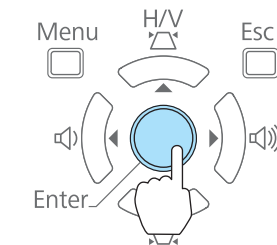

Questions and solutions are displayed as shown on the screen below.
Press the [Help] button to exit the Help.

The image is small.

- ❓ Is zoom set to minimum?
· Use the zoom ring to change the size of the image.
- ❓ Is the projector too close to the screen?
· Move the projector away from the screen.

[Esc] :Return

[Help] :Exit



See the following if the Help function does not provide a solution to the problem.

☞ "Problem Solving" [p.104](#)

If you are having a problem with the projector, first check the projector's indicators and refer to "Reading the Indicators" below. See the following if the indicators do not show clearly what the problem might be.

☛ "When the Indicators Provide No Help" [p.107](#)



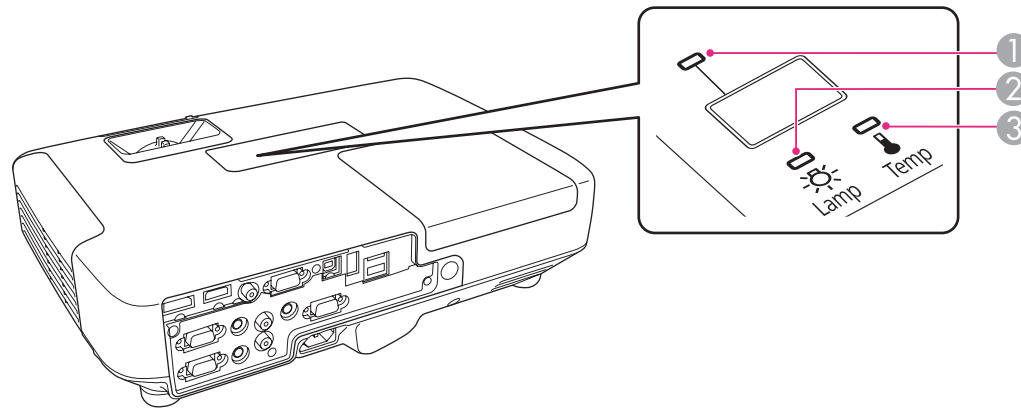

Reading the Indicators

The projector is provided with the following three indicators that indicate the operating status of the projector.



① Power indicator

Indicates the operating status.

-  Standby condition
When the [⏻] button is pressed in this condition, projection starts.
-  Preparing for network monitoring or cool down in progress
All buttons are disabled while the indicator is flashing.
-  Warming up
Warm-up time is about 30 seconds. After warm-up is complete, the indicator stops flashing.
The [⏻] button is disabled during warm-up.
-  Projecting

② Lamp indicator

Indicates the projection lamp status.





③ Temp indicator













Indicates the internal temperature status.

Refer to the following table to see what the indicators mean and how to remedy problems that they indicate.

If all indicators are off, check that the power cord is connected correctly and that the power is being supplied normally.

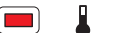
Sometimes, when the power cord is unplugged, the [⏻] indicator remains lit for a short period, but this is not a fault.

 : Lit
  : Flashing
  : Off
  : Varies according to the projector status

| Status | Cause | Remedy or Status |
|---|----------------------------------|--|
|    | Internal Error | Stop using the projector, remove the power plug from the electrical outlet, and contact your local dealer or the nearest address provided in the Epson Projector Contact List. ☞ Epson Projector Contact List |
|    | Fan Error Sensor Error | Stop using the projector, remove the power plug from the electrical outlet, and contact your local dealer or the nearest address provided in the Epson Projector Contact List. ☞ Epson Projector Contact List |
|    | High Temp Error (Overheating) | The lamp turns off automatically and projection stops. Wait for about five minutes. After about five minutes the projector switches to standby mode, so check the following two points. <ul style="list-style-type: none"> • Check that the air filter and air exhaust vent are clear, and that the projector is not positioned against a wall. • If the air filter is clogged, clean or replace it. <ul style="list-style-type: none"> ☞ "Cleaning the Air Filter" p.119 ☞ "Replacing the Air Filter" p.125 If the error continues after checking the points above, stop using the projector, remove the power plug from the electrical outlet, and contact your local dealer or the nearest address provided in the Epson Projector Contact List. ☞ Epson Projector Contact List |
| | | When using at an altitude of 1500 m or more, set High Altitude Mode to On. ☞ "Extended Menu" p.91 |
|    | Lamp Error Lamp Failure | Check the following two points. <ul style="list-style-type: none"> • Take out the lamp and check if it is cracked. <ul style="list-style-type: none"> ☞ "Replacing the Lamp" p.121 • Clean the air filter. <ul style="list-style-type: none"> ☞ "Cleaning the Air Filter" p.119 |

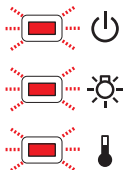
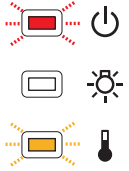
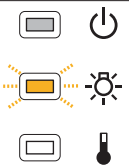
| Status | Cause | Remedy or Status |
|---|-------------------------------|--|
| | | <p>If the lamp is not cracked: Reinstall the lamp and turn on the power.</p> <p>If the error continues: Replace the lamp with a new one and then turn on the power.</p> <p>If the error continues: Stop using the projector, remove the power plug from the electrical outlet, and contact your local dealer or the nearest address provided in the Epson Projector Contact List.</p> <p>☛ Epson Projector Contact List</p> |
| | | <p>If the lamp is cracked: Contact your local dealer or the nearest address provided in the Epson Projector Contact List. (Images cannot be projected until the lamp is replaced.)</p> <p>☛ Epson Projector Contact List</p> |
| | | <p>When using at an altitude of 1500 m or more, set High Altitude Mode to On.</p> <p>☛ "Extended Menu" p.91</p> |
|  | Auto Iris Error Power Err. | <p>Stop using the projector, remove the power plug from the electrical outlet, and contact your local dealer or the nearest address provided in the Epson Projector Contact List.</p> <p>☛ Epson Projector Contact List</p> |
|  | High Temp Warning | <p>(This is not an abnormality. However, if the temperature rises too high again, projection stops automatically.)</p> <ul style="list-style-type: none"> • Check that the air filter and air exhaust vent are clear, and that the projector is not positioned against a wall. • If the air filter is clogged, clean or replace it. <ul style="list-style-type: none"> ☛ "Cleaning the Air Filter" p.119 ☛ "Replacing the Air Filter" p.125 |
|  | Replace Lamp | <p>Replace it with a new lamp.</p> <p>☛ "Replacing the Lamp" p.121</p> <p>If you continue to use the lamp after the replacement period has passed, the possibility that the lamp may explode increases. Replace it with a new lamp as soon as possible.</p> |













- See the following if the projector is not operating properly, even though the indicators are all showing normal.
 - ☛ "When the Indicators Provide No Help" [p.107](#)
- If the indicators are in a state not shown in this table, stop using the projector, remove the power plug from the electrical outlet, and contact your local dealer or the nearest address provided in the Epson Projector Contact List.
 - ☛ [Epson Projector Contact List](#)

When the Indicators Provide No Help

If any of the following problems occur and the indicators do not offer a solution, refer to the pages given for each problem.





Problems Relating to Images

| | |
|---|---|
| <ul style="list-style-type: none"> • No images appear Projection does not start, the projection area is completely black, or the projection area is completely blue. |  p.108 |
| <ul style="list-style-type: none"> • Moving images are not displayed Moving images being projected from a computer appear black and nothing is projected, or moving images are not played back on the computer. |  p.109 |
| <ul style="list-style-type: none"> • Projection stops automatically |  p.109 |
| <ul style="list-style-type: none"> • The message "Not supported" is displayed |  p.109 |
| <ul style="list-style-type: none"> • The message "No Signal" is displayed |  p.109 |
| <ul style="list-style-type: none"> • Images are fuzzy, out of focus, or distorted |  p.110 |
| <ul style="list-style-type: none"> • Interference or distortion appear in images |  p.111 |
| <ul style="list-style-type: none"> • The image is truncated (large) or small, the aspect ratio is not suitable, or the image has been reversed Only part of the image is displayed, the height and width ratios of the image are not correct, or the image may appear reversed from top to bottom or left to right. |  p.112 |
| <ul style="list-style-type: none"> • Image colors are not right The whole image appears purplish or greenish, images are black & white, or colors appear dull. |  p.112 |
| <ul style="list-style-type: none"> • Images appear dark |  p.113 |

Problems when projection starts

| | |
|---|---|
| <ul style="list-style-type: none"> • The projector does not turn on |  p.113 |
|---|---|

Other Problems

| | |
|--|---|
| <ul style="list-style-type: none"> • No sound can be heard or the sound is faint |  p.114 |
| <ul style="list-style-type: none"> • The remote control does not work |  p.115 |
| <ul style="list-style-type: none"> • I want to change the language for messages and menus |  p.115 |
| <ul style="list-style-type: none"> • Email is not received even if a problem occurs in the projector |  p.116 |
| <ul style="list-style-type: none"> • Image file names are not displayed correctly in Slideshow |  p.116 |

Problems Relating to Images

No images appear

| Check | Remedy |
|---|---|
| Did you press the [⏻] button? | Press the [⏻] button to turn the power on. |
| Are the indicators switched off? | The power cord is not connected correctly or power is not being supplied. Connect the projector's power cord correctly. ☛ "From Installation to Projection" p.30 Check that your electrical outlet or power source is functioning correctly. |
| Is A/V Mute active? | Press the [A/V Mute] button on the remote control to cancel A/V Mute. ☛ "Hiding the Image and Sound Temporarily (A/V Mute)" p.61 |
| Is the A/V mute slide closed? | Open the A/V mute slide. ☛ "Front/Top" p.11 |
| Are the Configuration menu settings correct? | Reset all of the settings. ☛ Reset - Reset All p.100 |
| Is the image to be projected completely black? (Only when projecting computer images) | Some input images, such as screen savers, may be completely black. |
| Is the image signal format setting correct? (Only when projecting images from a video source) | Change the setting according to the signal for the connected equipment. ☛ Signal - Video Signal p.88 |
| Is the USB cable connected correctly? (Only when projecting USB Display) | Check that the USB cable is connected correctly. Reconnect it if it is not connected or not connected properly. |
| Is Windows Media Center displayed in full screen? (Only when projecting using USB Display or network connection) | When Windows Media Center is displayed at full screen, you cannot project using USB Display or network connection. Reduce the screen size. |
| Is an application using the Windows DirectX function displayed? (Only when projecting using USB Display or network connection) | Applications using the Windows DirectX function may not display images correctly. |

Moving images are not displayed

| Check | Remedy |
|--|---|
| Is the computer's image signal being output to the LCD and the monitor? (Only when projecting images from a laptop computer or a computer with a built-in LCD screen) | Change the image signal from the computer to external output only. Check your computer's documentation, or contact the computer's manufacturer. |
| Are the contents of the moving image you are trying to project copyright protected? | The projector may not be able to project copyright protected moving images that are being played back on a computer. For more details, see the user's guide supplied with the player. |

Projection stops automatically

| Check | Remedy |
|---|--|
| Is Sleep Mode set to On ? | Press the [⏻] button to turn the power on. If you do not want to use Sleep Mode, change the setting to Off . ☛ Extended - Operation - Sleep Mode p.91 |

The message "Not supported" is displayed

| Check | Remedy |
|---|--|
| Is the image signal format setting correct? (Only when projecting images from a video source) | Change the setting according to the signal for the connected equipment. ☛ Signal - Video Signal p.88 |
| Do the image signal resolution and the refresh rate correspond to the mode? (Only when projecting computer images) | Refer to the computer's documentation for how to change the image signal resolution and the refresh rate output from the computer. ☛ "Supported Monitor Displays" p.133 |

The message "No Signal" is displayed

| Check | Remedy |
|-------------------------------------|---|
| Are the cables connected correctly? | Check that all the cables required for projection are securely connected. Check that no cables are disconnected and that there are no poor contacts in the cables. ☛ "From Installation to Projection" p.30 |

| Check | Remedy |
|---|--|
| Is the correct port selected? | Change the image by pressing the [Source Search] button on the remote control or the control panel. ☛ "Automatically Detect Input Signals and Change the Projected Image (Source Search)" p.31 |
| Is the power for the computer or video source turned on? | Turn the power on for the equipment. |
| Are the image signals being output to the projector? (Only when projecting images from a laptop computer or a computer with a built-in LCD screen) | If the image signals are only being output to the computer's LCD monitor or to the accessory monitor, you need to change the output to an external destination as well as the computer's own monitor. For some computer models, when the image signals are output externally, they no longer appear on the LCD monitor or accessory monitor. If the connection is made while the power of the projector or computer is already turned on, the Fn key (Function key) that changes the computer's image signal to external output may not work. Turn the power for the computer and the projector off and then back on again. ☛ "From Installation to Projection" p.30 ☛ Computer's documentation |

Images are fuzzy, out of focus, or distorted

| Check | Remedy |
|---|---|
| Is Auto V-Keystone set to Off ? | Setting it to On enables Auto V-Keystone. ☛ Settings - Keystone - H/V-Keystone - Auto V-Keystone p.90 If you are using the projector with this setting off, manually adjust the projected image. ☛ "Correcting manually" p.37 |
| Is the focus adjusted correctly? | Turn the focus ring to adjust the focus. ☛ "Correcting the Focus" p.41 |
| Is the projector at the correct distance? | Is it projecting outside of the recommended projection distance range? Setup within the recommended range. ☛ "Screen Size and Projection Distance" p.130 |
| Is the keystone adjustment value too large? | Lower the projection angle to reduce the amount of keystone correction. ☛ "Adjusting the Image Position" p.40 |
| Has condensation formed on the lens? | If the projector is suddenly taken from a cold environment to a warm environment, or if sudden ambient temperature changes occur, condensation may form on the surface of the lens, and this may cause the images to appear fuzzy. Set the projector up in the room about one hour before it is used. If condensation forms on the lens, turn the projector off and wait for the condensation to disappear. |

Interference or distortion appear in images

| Check | Remedy |
|--|---|
| Is the image signal format setting correct? (Only when projecting images from a video source) | Change the setting according to the signal for the connected equipment. ☛ Signal - Video Signal p.88 |
| Are the cables connected correctly? | Check that all the cables required for projection are securely connected. ☛ "Connecting Equipment" p.23 |
| Is an extension cable being used? | If an extension cable is used, electrical interference may affect the signals. Use the cables supplied with the projector to check if the cables you are using may be causing the problem. |
| Is the correct resolution selected? (Only when projecting computer images) | Set the computer so that the signals being output are compatible with the projector. ☛ "Supported Monitor Displays" p.133 ☛ Computer's documentation |
| Are the <u>Sync</u> and <u>Tracking</u> settings adjusted correctly? (Only when projecting computer images) | Press the [Auto] button on the remote control or the [↵] button on the control panel to perform automatic adjustment. If the images are not adjusted correctly even after performing automatic adjustment, you can also make adjustments from the Configuration menu. ☛ Signal - Tracking, Sync. p.88 |
| Is the Resolution set to anything other than Auto ? (Only when projecting on a split screen) | The image may be collapsed if the Resolution on the Configuration menu and the resolution of the projected image are not the same. If the image is collapsed, set the Resolution to Auto . ☛ Signal - Resolution p.88 |
| Is Transfer layered window selected? (Only when projecting USB Display) | Click All Programs - EPSON Projector - Epson USB Display - Epson USB Display Vx.xx Settings , and then clear the Transfer layered window checkbox. |

The mouse cursor flickers (only when projecting USB Display)

| Check | Remedy |
|--|--|
| Is Make the movement of the mouse pointer smooth. selected? | Click All Programs - EPSON Projector - Epson USB Display - Epson USB Display Vx.xx Settings , and then select Make the movement of the mouse pointer smooth. (This is not available for Windows 2000.) For Windows Vista/7, Windows Aero is disabled when this is selected. |

The image is truncated (large) or small, the aspect is not suitable, or the image has been reversed

| Check | Remedy |
|---|--|
| Is a wide panel computer image being projected? (Only when projecting computer images) | Change the setting according to the signal for the connected equipment. ☛ Signal - Resolution p.88 |
| Is the image still being enlarged by E-Zoom? | Press the [Esc] button on the remote control to cancel E-Zoom. ☛ "Enlarging Part of the Image (E-Zoom)" p.63 |
| Is the image position adjusted correctly? | (Only when projecting analog RGB signals input from the Computer port) Press the [Auto] button on the remote control or the [↵] button on the control panel to adjust the position. You can also adjust the position from the Configuration menu. ☛ Signal - Position p.88 |
| Is the computer set for dual display? (Only when projecting computer images) | If dual display is activated in the Display Properties of the computer's Control Panel, only about half of the image on the computer screen is projected. To display the entire image on the computer screen, turn off the dual display setting. ☛ Computer video driver documentation |
| Is the correct resolution selected? (Only when projecting computer images) | Set the computer so that the signals being output are compatible with the projector. ☛ "Supported Monitor Displays" p.133 ☛ Computer's documentation |
| Is the projection mode correct? | Depending on how the projector is installed, set the projection mode from one of the following: Front , Front/Ceiling , Rear , or Rear/Ceiling . ☛ Extended - Projection p.91 ☛ "Installation Methods" p.20 |

Image colors are not right

| Check | Remedy |
|---|--|
| Do the input signal settings match the signals from the connected device? | Change the following settings according to the signal for the connected equipment. <ul style="list-style-type: none"> • When the image is from a device connected to the Computer port ☛ Signal - Input Signal p.88 • When the image is from a device connected to the Video port ☛ Signal - Video Signal p.88 |
| Is the image brightness adjusted correctly? | Adjust the Brightness setting from the Configuration menu. ☛ Image - Brightness p.87 |

| Check | Remedy |
|--|--|
| Are the cables connected correctly? | Check that all the cables required for projection are securely connected. Check that no cables are disconnected and that there are no poor contacts in the cables. ☛ "Connecting Equipment" p.23 |
| Is the <u>contrast</u>  adjusted correctly? | Adjust the Contrast setting from the Configuration menu. ☛ Image - Contrast p.87 |
| Is the color adjustment set correctly? | Adjust the Gamma, RGB, or RGBCMY setting from the Configuration menu. ☛ Image - Advanced p.87 ☛ "Adjusting the Image" p.41 |
| Are the color saturation and tint adjusted correctly? (Only when projecting images from a video source) | Adjust the Color Saturation and Tint settings from the Configuration menu. ☛ Image - Color Saturation, Tint p.87 |

Images appear dark

| Check | Remedy |
|---|--|
| Is the image brightness set correctly? | Adjust the Brightness and Power Consumption settings from the Configuration menu. ☛ Image - Brightness p.87 ☛ Settings - Power Consumption p.90 |
| Is the <u>contrast</u>  adjusted correctly? | Adjust the Contrast setting from the Configuration menu. ☛ Image - Contrast p.87 |
| Is it time to replace the lamp? | When the lamp is nearly ready for replacement, the images become darker and the color quality becomes poorer. When this happens, replace the lamp with a new lamp. ☛ "Replacing the Lamp" p.121 |

Problems when Projection Starts

The projector does not turn on

| Check | Remedy |
|-------------------------------|--|
| Did you press the [⏻] button? | Press the [⏻] button to turn the power on. |

| Check | Remedy |
|---|---|
| Are the indicators switched off? | The power cord is not connected correctly or power is not being supplied. Disconnect and then reconnect the power cord. ☛ "From Installation to Projection" p.30 Check that your electrical outlet or power source is functioning correctly. |
| Do the indicators turn on and off when the power cord is touched? | There is probably a poor contact in the power cord, or the power cord may be defective. Reinsert the power cord. If this does not solve the problem, stop using the projector, disconnect the power cord from the electrical outlet, and contact your local dealer or the nearest address provided in the Epson Projector Contact List. ☛ Epson Projector Contact List |
| Is the Control Panel Lock set to Full Lock ? | Press the [⏻] button on the remote control. If you do not want to use Control Panel Lock , change the setting to Off . ☛ Settings - Control Panel Lock p.90 |
| Is the correct setting for the remote receiver selected? | Check the Remote Receiver from the Configuration menu. ☛ Settings - Remote Receiver p.90 |

Other Problems

No sound can be heard or the sound is faint

| Check | Remedy |
|---|---|
| Check that the audio/video cable is securely attached to both the projector and audio source. | Disconnect the cable from the Audio port, and then reconnect the cable. |
| Is the projector volume set to the minimum? | Adjust the volume so that sound can be heard. ☛ Settings - Volume p.90 ☛ "Adjusting the Volume" p.41 |
| Is the volume for the computer or from the image source set to the minimum? | Adjust the volume so that sound can be heard. |
| Is A/V Mute active? | Press the [A/V Mute] button on the remote control to cancel A/V Mute. ☛ "Hiding the Image and Sound Temporarily (A/V Mute)" p.61 |
| Is the audio cable's specification "No resistance"? | When using a commercially available audio cable, make sure it is labeled "No resistance". |
| Is it connected with an HDMI cable? | If no audio is output when connecting via an HDMI cable, set the connected equipment to PCM output. |

| Check | Remedy |
|---|---|
| Is Output audio from the projector selected? (Only when projecting USB Display) | Click All Programs - EPSON Projector - Epson USB Display - Epson USB Display Vx.xx Settings , and then select Output audio from the projector . |

The remote control does not work

| Check | Remedy |
|--|---|
| Is the remote control light-emitting area pointing towards the remote receiver on the projector during operation? | Point the remote control towards the remote receiver. ☛ "Remote control operating range" p.18 |
| Is the remote control too far from the projector? | The operating range for the remote control is about 6 m. ☛ "Remote control operating range" p.18 |
| Is direct sunlight or strong light from fluorescent lamps shining onto the remote receiver? | Set the projector up in a location where strong light does not shine onto the remote receiver. Or set the remote receiver to Off from Remote Receiver in the Configuration menu. ☛ Settings - Remote Receiver p.90 |
| Is the correct setting for the Remote Receiver selected? | Check the Remote Receiver from the Configuration menu. ☛ Settings - Remote Receiver p.90 |
| Are the batteries dead or have the batteries been inserted correctly? | Make sure the batteries are inserted correctly or replace the batteries with new ones if necessary. ☛ "Replacing the remote control batteries" p.17 |
| When adjusting color difference using the multi-screen color adjustment function, have you specified the correct projector ID for the projector you want to operate? | While holding the [ID] button, press the number button that matches the ID of the projector you want to operate. ☛ "Setting an ID and using the remote control" p.65 |

I want to change the language for messages and menus

| Check | Remedy |
|------------------------------|--|
| Change the Language setting. | Adjust the Language setting from the Configuration menu. ☛ Extended - Language p.91 |

Email is not received even if a problem occurs in the projector

| Check | Remedy |
|--|---|
| Is Standby Mode set to Communication On ? | To use the Mail Notification function when the projector is in standby, set Communication On in Standby Mode from the Configuration menu. ☛ Extended - Standby Mode p.91 |
| Did a fatal abnormality occur and the projector come to a sudden stop? | When the projector comes to a sudden stop, email cannot be sent. If the abnormal state continues, contact your local dealer or the nearest address provided in the Epson Projector Contact List. ☛ Epson Projector Contact List |
| Is power being supplied to the projector? | Check that your electrical outlet or power source is functioning correctly. |
| Is the Mail Notification function set correctly in the Configuration menu? | An error notification email is sent according to the Mail settings in the Configuration menu. Check if it is set correctly. ☛ "Mail menu" p.96 |

Image file names are not displayed correctly in Slideshow



| Check | Remedy |
|---|---|
| Is the file name too long? | The file name can be up to 8 characters long. For file names longer than this, the middle of the name is omitted to shorten the name to 8 characters. |
| Are there any 2-byte characters in the file name? | Only alphanumeric characters and symbols can be used in file names. Any other characters are replaced with a question mark (?). |

Cannot change settings using a Web browser

| Check | Remedy |
|---------------------------------------|---|
| Are the user ID and password correct? | Enter "EPSONWEB" as the user ID. This cannot be changed. Enter the user ID even if the password setting is disabled. Enter the characters set for the Web Control Password as the password. The default password is "admin". |

Check the numbers and then apply the following countermeasures. If you cannot resolve the problem, contact your network administrator, or contact your local dealer or the nearest address provided in the Epson Projector Contact List.

 [Epson Projector Contact List](#)

| Event ID | Cause | Remedy |
|------------------------------|---|---|
| 0432 0435 | Failed to startup EasyMP Network Projection. | Restart the projector. |
| 0434 0481 0482 0485 | Network communication is unstable. | Check the network communication status, and reconnect after waiting for a while. |
| 0433 | Cannot play transferred images. | Restart EasyMP Network Projection. |
| 0484 | Communication was disconnected from the computer. | |
| 04FE | EasyMP Network Projection ended unexpectedly. | Check the status of network communications. Restart the projector. |
| 04FF | A system error occurred in the projector. | Restart the projector. |
| 0894 | Communication was disconnected because the projector connected to an unauthorized access point. | Contact your network administrator for more information. |
| 0898 | Failed to acquire DHCP. | Check the DHCP server to see if it is operating correctly and check the LAN cable to see if it is connected correctly. If you are not using DHCP, turn off the DHCP setting.  "Network Menu" p.93 |
| 0899 | Other communication errors | If restarting the projector or EasyMP Network Projection does not solve the problem, contact your local dealer or the nearest address provided in the Epson Projector Contact List.  Epson Projector Contact List |



Maintenance

This chapter provides information on maintenance procedures to ensure the best level of performance from the projector for a long time to come.

You should clean the projector if it becomes dirty or if the quality of projected images starts to deteriorate.



Caution

Turn off the projector's power before cleaning. Otherwise, it could cause an electric shock.

Cleaning the Projector's Surface

Clean the projector's surface by wiping it gently with a soft cloth.

If the projector is particularly dirty, moisten the cloth with water containing a small amount of neutral detergent, and then firmly wring the cloth dry before using it to wipe the projector's surface.

Attention

Do not use volatile substances such as wax, alcohol, or thinner to clean the projector's surface. The quality of the case may change or become discolored.

Cleaning the Lens

Use a commercially available cloth for cleaning glasses to gently wipe the lens.



Warning

Do not use sprays that contain flammable gas to remove dust and lint from the lens. The projector may catch fire due to the high internal temperature of the lamp.

Attention

Do not rub the lens with harsh materials or subject the lens to shocks, as it can easily become damaged.

Cleaning the Air Filter

Clean the air filter and the air intake vent when the following message is displayed.

"The projector is overheating. Make sure nothing is blocking the air vent, and clean or replace the air filter."

Attention

- If dust collects on the air filter, it can cause the internal temperature of the projector to rise, and this can lead to problems with operation and shorten the optical engine's service life. Clean the air filter immediately when the message is displayed.
- Do not rinse the air filter in water. Do not use detergents or solvents.

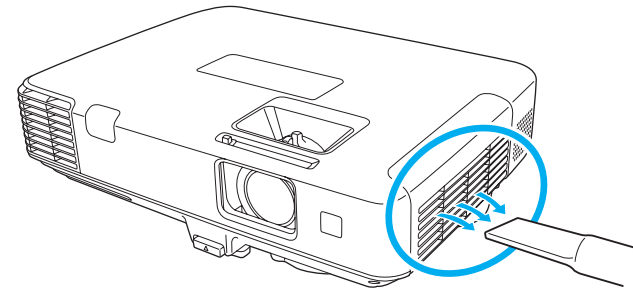



- If a message is frequently displayed, even after cleaning, it is time to replace the air filter. Replace it with a new air filter.
 - ☛ "Replacing the Air Filter" [p.125](#)
- It is recommended that you clean these parts at least once every three months. Clean them more often than this if using the projector in a particularly dusty environment.

This section explains how to replace the lamp and the air filter.

Replacing the Lamp

Lamp replacement period

It is time to replace the lamp when:

- The following message is displayed.
"Time to replace the lamp. Please contact your Epson projector reseller or visit www.epson.com to purchase."

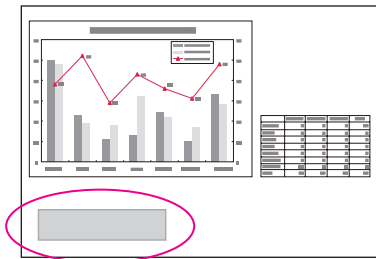

The message is displayed for 30 seconds.

- The lamp indicator flashes orange.

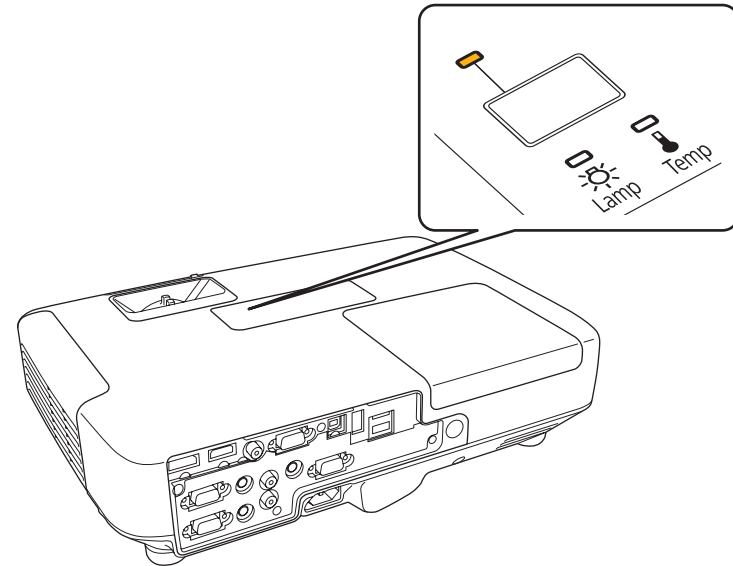

- The projected image gets darker or starts to deteriorate.

Attention

- The lamp replacement message is set to appear after the following time periods in order to maintain the initial brightness and quality of the projected images.

For **EB-1960/EB-1950/EB-1940W**

When using **Power Consumption** continually at **Normal**: About 2400 hours

When using **Power Consumption** continually at **ECO**: About 3900 hours

For **EB-1930**

When using **Power Consumption** continually at **Normal**: About 3400 hours

When using **Power Consumption** continually at **ECO**: About 4900 hours

☛ **Settings - Power Consumption** p.90

- If you continue to use the lamp after the replacement period has passed, the possibility that the lamp may explode increases. When the lamp replacement message appears, replace the lamp with a new one as soon as possible, even if it is still working.
- Do not repeatedly turn off the power and immediately back on. Turning the power on and off frequently may shorten the lamp's operating life.
- Depending on the characteristics of the lamp and the way it has been used, the lamp may become darker or stop working before the lamp warning message appears. You should always have a spare lamp unit ready in case it is needed.

How to replace the lamp

The lamp can be replaced even when the projector is suspended from a ceiling.

Warning

- When replacing the lamp because it has stopped illuminating, there is a possibility that the lamp may be broken. If replacing the lamp of a projector which has been installed on the ceiling, you should always assume that the lamp is cracked, and you should stand to the side of the lamp cover, not underneath it. Remove the lamp cover gently. Be careful when removing the lamp cover as shards of glass may fall out and could cause an injury. If any shards of glass get into your eyes or mouth, contact your local physician immediately.
- Never disassemble or remodel the lamp. If a modified or disassembled lamp is installed in the projector and used, it could cause a fire, electric shock, or an accident.

Caution

Wait until the lamp has cooled down sufficiently before removing the lamp cover. If the lamp is still hot, burns or other injuries may result. It takes about one hour after the power has been turned off for the lamp to be cool enough.

- 1** After you turn off the projector's power and the confirmation buzzer beeps twice, disconnect the power cord.
- 2** Wait until the lamp has sufficiently cooled down, and then remove the lamp cover at the top of the projector.
Loosen the Lamp cover fixing screw with the screwdriver supplied with the new lamp unit or a cross-head screwdriver. Then slide the lamp cover straight forward and lift it to remove.

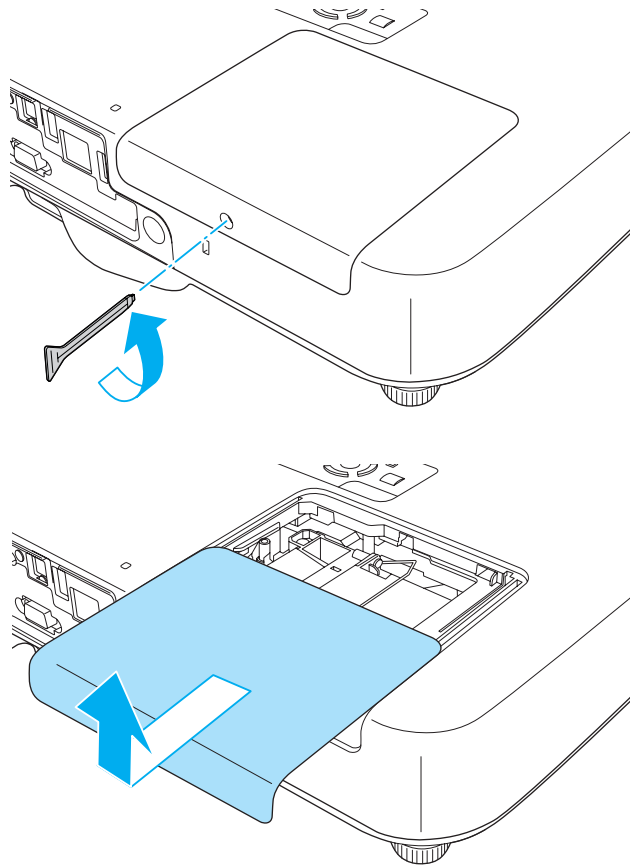

3 Loosen the two lamp fixing screws.

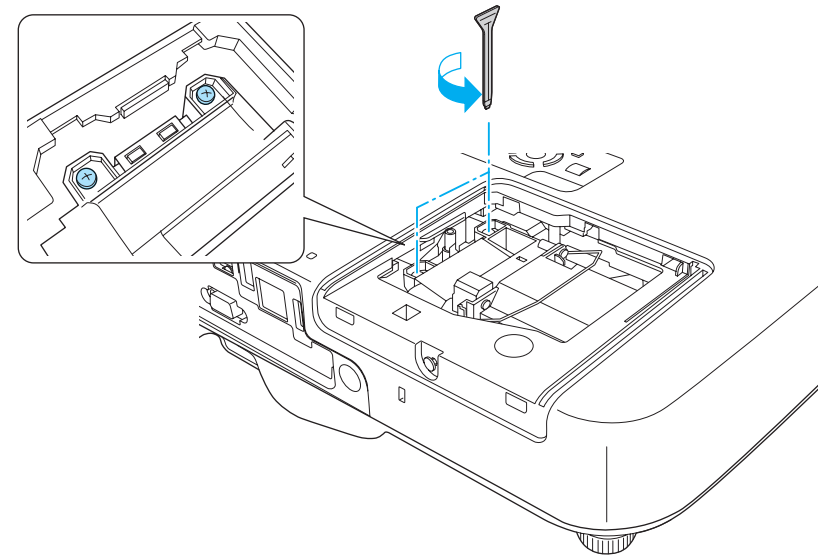

4 Take out the old Lamp by pulling the handle.
If the Lamp is cracked, replace it with a new lamp, or contact your local dealer for further advice.

 [Epson Projector Contact List](#)

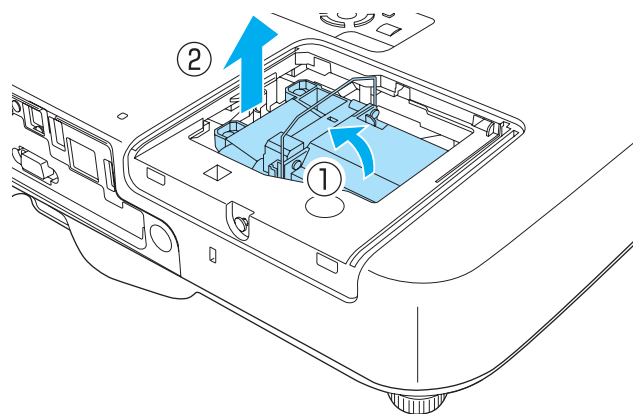

- 5** Install the new lamp.
Insert the new Lamp along the guide rail in the correct direction so that it fits in place, push in firmly, and once it is fully inserted tighten the two screws.

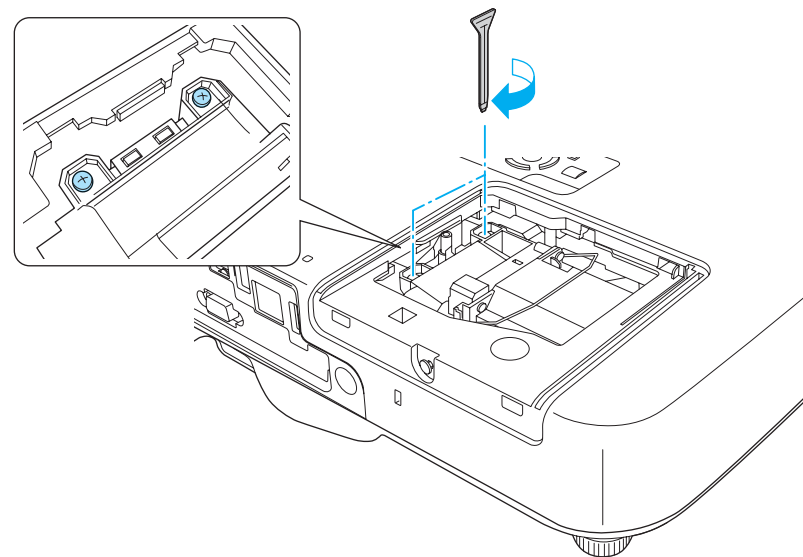
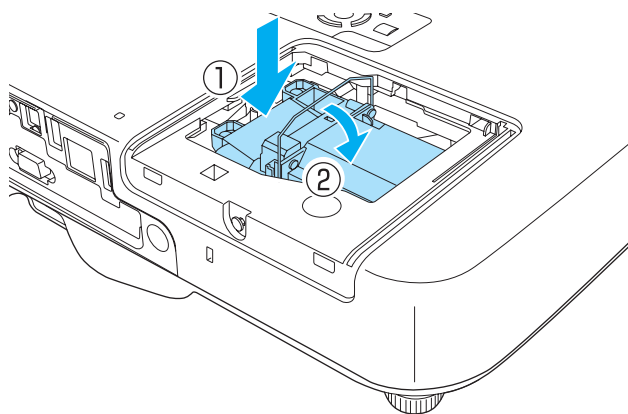

- 6** Replace the lamp cover.

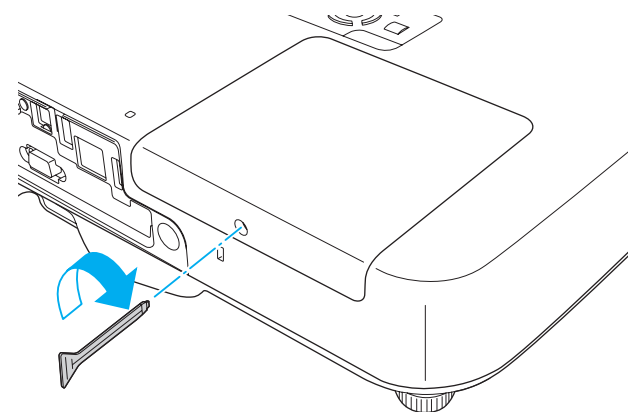

Attention

- Make sure you install the lamp securely. If the lamp cover is removed, the power turns off automatically as a safety precaution. If the lamp or the lamp cover is not installed correctly, the power does not turn on.
- This product includes a lamp component that contains mercury (Hg). Please consult your local regulations regarding disposal or recycling. Do not dispose of it with normal waste.

Resetting the lamp hours

The projector records how long the lamp is turned on and a message and indicator notify you when it is time to replace the lamp. After replacing the lamp, make sure you reset the **Lamp Hours** from the Configuration menu.

☛ "Reset Menu" p.100



Only reset the **Lamp Hours** after the lamp has been replaced. Otherwise the lamp replacement period is not indicated correctly.

Replacing the Air Filter

Air filter replacement period

If the message is displayed frequently even though the air filter has been cleaned, replace the air filter.

How to replace the air filter

The air filter can be replaced even when the projector is suspended from a ceiling.

1 After you turn off the projector's power and the confirmation buzzer beeps twice, disconnect the power cord.

2 Open the air filter cover.
Slide the air filter cover operation knob, and open the air filter cover.

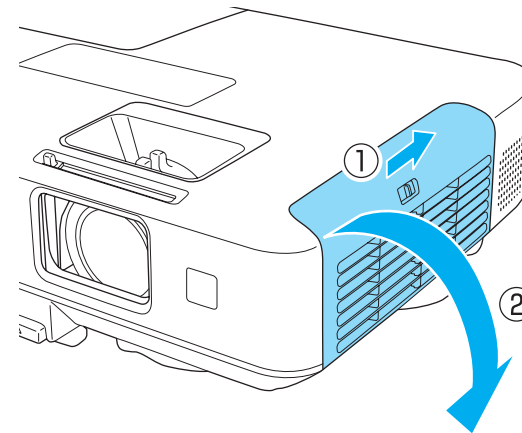

3 Remove the air filter.
Grip the tab in the center of the air filter, and pull it straight out.

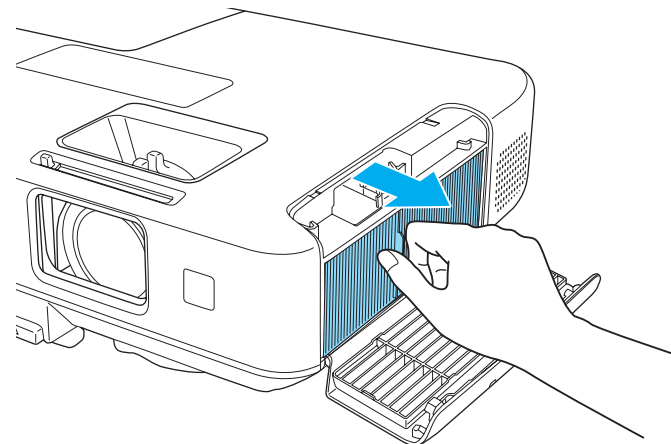

- 4** Install the new air filter.
Press until it clicks into place.

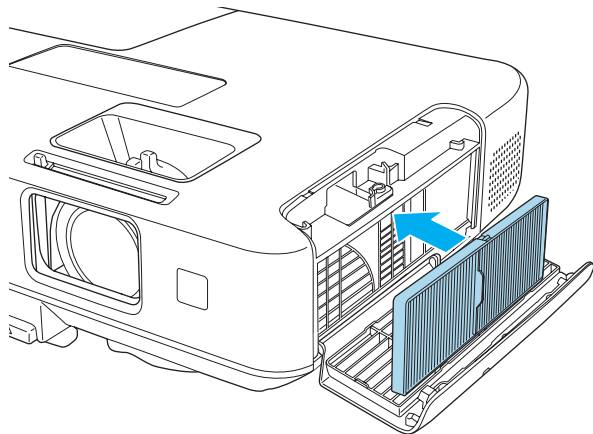

- 5** Close the air filter cover.



Dispose of used air filters properly in accordance with your local regulations.

Material of the frame part: Polypropylene

Material of the filter part: Polypropylene



Appendix

The following optional accessories and consumables are available. Please purchase these products as and when needed. The following list of optional accessories and consumables is current as of: February 2012. Details of accessories are subject to change without notice and availability may vary depending on the country of purchase.

Optional Accessories

| |
|--|
| Interactive Unit ELPIU01 |
| Use when operating the computer screen on the projection surface. |
| Document Camera ELPDC06/ELPDC11 |
| Use when projecting images such as books, OHP documents, or slides. |
| Soft carrying case ELPKS65 |
| Use this case to carry the projector by hand. |
| 50" portable screen ELPSC32 |
| A compact screen that can be carried easily. (Aspect Ratio 4:3) |
| 60" portable screen ELPSC27 |
| 80" portable screen ELPSC28 |
| 100" screen ELPSC29 |
| Portable roll-type screens. (aspect ratio 4:3) |
| 70" portable screen ELPSC23 |
| 80" portable screen ELPSC24 |
| 90" portable screen ELPSC25 |
| Portable roll-type screens. (aspect ratio 16:10) |
| 53" portable screen ELPSC30 |
| 64" portable screen ELPSC31 |
| Portable magnetic screens. (aspect ratio 4:3) |
| 80" portable screen ELPSC26 |
| This is a multi-aspect screen. |

Computer cable ELPKC02

(1.8 m - for mini D-Sub15-pin/mini D-Sub 15pin)

This is the same as the computer cable supplied with the projector.

Computer cable ELPKC09

(3 m - for mini D-Sub15-pin/mini D-Sub 15pin)

Computer cable ELPKC10

(20 m - for mini D-Sub15-pin/mini D-Sub 15pin)

Use one of these longer cables if the computer cable supplied with the projector is too short.

D port cable ELPKC22

(Mini D-Sub 15-pin/3 m for D port)

Use this when connecting to the D port on an image source.

Component video cable ELPKC19

(3 m - for mini D-Sub 15-pin/RCA male×3)

Use to connect a [component video](#) source.

Quick Wireless Connection USB Key ELPAP09

Use when you want to quickly establish one-to-one connection between the projector and a computer with Windows installed.

Ceiling pipe (450 mm)* ELPFP13

Ceiling pipe (700 mm)* ELPFP14

Use when installing the projector on a high ceiling.

Ceiling mount* ELPMB23

Use when installing the projector on a ceiling.

* Special expertise is required to suspend the projector from a ceiling. Contact your local dealer or the nearest address provided in the Epson Projector Contact List.

 [Epson Projector Contact List](#)



Consumables

Lamp unit ELPLP74 (EB-1930 only)

Lamp unit ELPLP75

Use as a replacement for used lamps.

Air filter ELPAF41

Use as a replacement for used air filters.

Projection Distance (For EB-1960/EB-1950/EB-1930)

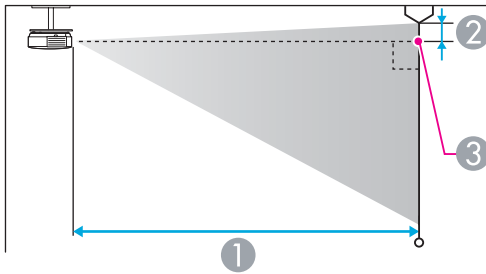
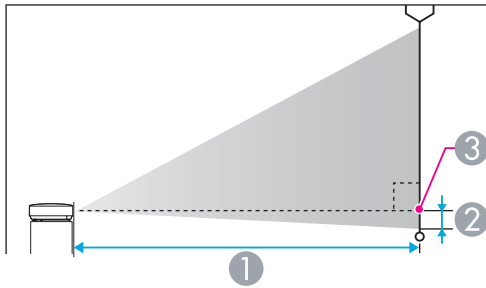

- ① Projection distance
- ② Distance from the center of the lens to the base of the screen (or to the top of the screen, if suspended from a ceiling)
- ③ Center of lens

Unit: cm

| 4:3 Screen Size | | ① | ② |
|-----------------|-------|----------------------------------|----|
| | | Minimum (Wide) to Maximum (Tele) | |
| 30" | 61x46 | 83 - 136 | -5 |
| 40" | 81x61 | 111 - 182 | -6 |

| 4:3 Screen Size | | ① | ② |
|-----------------|---------|----------------------------------|-----|
| | | Minimum (Wide) to Maximum (Tele) | |
| 50" | 100x76 | 140 - 229 | -8 |
| 60" | 120x91 | 169 - 275 | -10 |
| 80" | 160x120 | 226 - 368 | -13 |
| 100" | 200x150 | 283 - 460 | -16 |
| 150" | 300x230 | 426 - 692 | -24 |
| 200" | 410x300 | 568 - 923 | -32 |
| 250" | 500x380 | 711 - 1155 | -40 |
| 300" | 610x457 | 854 - 1386 | -48 |

Unit: cm

| 16:9 Screen Size | | ① | ② |
|------------------|---------|----------------------------------|-----|
| | | Minimum (Wide) to Maximum (Tele) | |
| 30" | 66x37 | 91 - 149 | +1 |
| 40" | 89x50 | 122 - 199 | +1 |
| 50" | 110x62 | 153 - 249 | +2 |
| 60" | 130x75 | 184 - 300 | +2 |
| 80" | 180x100 | 246 - 401 | +3 |
| 100" | 220x120 | 308 - 502 | +3 |
| 150" | 330x190 | 464 - 754 | +5 |
| 200" | 440x250 | 619 - 1006 | +7 |
| 250" | 550x310 | 775 - 1258 | +9 |
| 275" | 609x343 | 853 - 1384 | +10 |

Projection Distance (For EB-1940W)

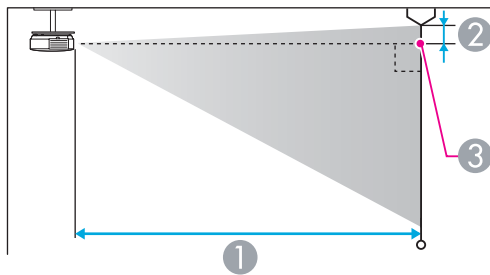
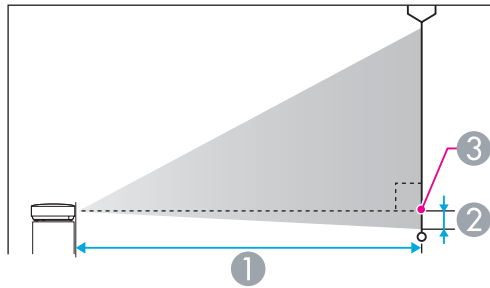

- ① Projection distance
- ② Distance from the center of the lens to the base of the screen (or to the top of the screen, if suspended from a ceiling)
- ③ Center of lens

Unit: cm

| 4:3 Screen Size | | ① Minimum (Wide) to Maximum (Tele) | ② |
|-----------------|--------|---------------------------------------|----|
| 30" | 61x46 | 100 - 164 | -1 |
| 40" | 81x61 | 134 - 219 | -2 |
| 50" | 100x76 | 169 - 275 | -2 |

| 4:3 Screen Size | | ① Minimum (Wide) to Maximum (Tele) | ② |
|-----------------|---------|---------------------------------------|-----|
| 60" | 120x91 | 203 - 331 | -2 |
| 80" | 160x120 | 271 - 442 | -3 |
| 100" | 200x150 | 340 - 553 | -4 |
| 120" | 244x183 | 408 - 664 | -5 |
| 150" | 300x230 | 511 - 831 | -6 |
| 200" | 410x300 | 682 - 1108 | -8 |
| 250" | 500x380 | 854 - 1386 | -10 |

Unit: cm

| 16:9 Screen Size | | ① Minimum (Wide) to Maximum (Tele) | ② |
|------------------|---------|---------------------------------------|-----|
| 30" | 66x37 | 91 - 149 | +1 |
| 40" | 89x50 | 122 - 199 | +1 |
| 50" | 110x62 | 153 - 249 | +2 |
| 60" | 130x75 | 184 - 300 | +2 |
| 80" | 180x100 | 246 - 401 | +3 |
| 100" | 220x120 | 308 - 502 | +3 |
| 150" | 330x190 | 464 - 754 | +5 |
| 200" | 440x250 | 619 - 1006 | +7 |
| 250" | 550x310 | 775 - 1258 | +9 |
| 275" | 609x343 | 853 - 1384 | +10 |



Unit: cm

| 16:10 Screen Size | | ① | ② |
|-------------------|---------|----------------------------------|----|
| | | Minimum (Wide) to Maximum (Tele) | |
| 30" | 64x40 | 88 - 144 | -1 |
| 40" | 86x54 | 118 - 193 | -1 |
| 50" | 110x67 | 149 - 243 | -2 |
| 60" | 130x81 | 179 - 292 | -2 |
| 80" | 170x110 | 239 - 390 | -3 |
| 100" | 220x130 | 300 - 488 | -3 |
| 150" | 320x200 | 451 - 733 | -5 |
| 200" | 430x270 | 603 - 979 | -7 |
| 250" | 540x340 | 754 - 1224 | -8 |
| 280" | 605x377 | 845 - 1371 | -9 |

Supported Resolutions

Computer signals (analog RGB)

| Signal | Refresh Rate (Hz) | Resolution (dots) |
|-------------|-------------------|-------------------|
| VGA | 60/72/75/85 | 640x480 |
| SVGA | 56/60/72/75/85 | 800x600 |
| XGA | 60/70/75/85 | 1024x768 |
| WXGA | 60 | 1280x768 |
| | 60 | 1366x768 |
| | 60/75/85 | 1280x800 |
| WXGA+ | 60/75/85 | 1440x900 |
| WXGA++ | 60 | 1600x900 |
| SXGA | 70/75/85 | 1152x864 |
| | 60/75/85 | 1280x1024 |
| | 60/75/85 | 1280x960 |
| SXGA+ | 60/75 | 1400x1050 |
| WSXGA+*1, 2 | 60 | 1680x1050 |
| UXGA | 60 | 1600x1200 |
| MAC13" | 67 | 640x480 |
| MAC16" | 75 | 832x624 |
| MAC19" | 75 | 1024x768 |
| | 59 | 1024x768 |

| Signal | Refresh Rate (Hz) | Resolution (dots) |
|--------|-------------------|-------------------|
| MAC21" | 75 | 1152x870 |

*1 EB-1940W only

*2 Only compatible when **Wide** is selected as the **Resolution** from the Configuration menu.

Even when signals other than those mentioned above are input, it is likely that the image can be projected. However, not all functions may be supported.

Component Video

| Signal | Refresh Rate (Hz) | Resolution (dots) |
|--------------|-------------------|-------------------|
| SDTV (480i) | 60 | 720x480 |
| SDTV (576i) | 50 | 720x576 |
| SDTV (480p) | 60 | 720x480 |
| SDTV (576p) | 50 | 720x576 |
| HDTV (720p) | 50/60 | 1280x720 |
| HDTV (1080i) | 50/60 | 1920x1080 |

Composite video

| Signal | Refresh Rate (Hz) | Resolution (dots) |
|------------|-------------------|-------------------|
| TV (NTSC) | 60 | 720x480 |
| TV (SECAM) | 50 | 720x576 |
| TV (PAL) | 50/60 | 720x576 |

Input signal from the HDMI port and DisplayPort

| Signal | Refresh Rate (Hz) | Resolution (dots) |
|--------|-------------------|-------------------|
| VGA | 60 | 640x480 |



| Signal | Refresh Rate (Hz) | Resolution (dots) |
|----------------------|-------------------|-------------------|
| SVGA | 60 | 800x600 |
| XGA | 60 | 1024x768 |
| WXGA | 60 | 1280x800 |
| | 60 | 1280x768** |
| | 60 | 1366x768 |
| WXGA+ | 60 | 1440x900 |
| WXGA++ | 60 | 1600x900 |
| WSXGA+ | 60 | 1680x1050 |
| SXGA | 60 | 1280x960 |
| | 60 | 1280x1024 |
| SXGA+ | 60 | 1400x1050 |
| UXGA | 60 | 1600x1200 |
| SDTV (480i*/480p) | 60 | 720x480 |
| SDTV (576i*/576p) | 50 | 720x576 |
| HDTV (720p) | 50/60 | 1280x720 |
| HDTV (1080i) | 50/60 | 1920x1080 |
| HDTV (1080p) | 24*/30*/50/60 | 1920x1080 |

* HDMI input only

** DisplayPort input only

Projector General Specifications

| Product name | | EB-1960 | EB-1950 | EB-1940W | EB-1930 |
|-----------------------|-------------------|--|---------|--|--|
| Dimensions | | 377 (W) x 108 (H) x 271 (D) mm | | | |
| LCD panel size | | 0.63" | | 0.59" Wide | 0.63" |
| Display method | | Polysilicon TFT active matrix | | | |
| Resolution | | 786,432 pixels XGA (1024 (W) x 768 (H) dots)x 3 | | 1,024,000 pixels XGA (1280 (W) x 800 (H) dots)x 3 | 786,432 pixels XGA (1024 (W) x 768 (H) dots)x 3 |
| Focus adjustment | | Manual | | | |
| Zoom adjustment | | 1-1.6 | | | |
| Lamp | | UHE lamp, 245 W Model No.: ELPLP75 | | | UHE lamp 215 W Model No.: ELPLP74 |
| Max. audio output | | 10 W | | | |
| Speaker | | 1 | | | |
| Power supply | | 100-240V AC±10% 50/60Hz 3.6-1.6A | | | 100-240V AC±10% 50/60Hz 3.1-1.4A |
| Power consumption | 100 to 120 V area | Operating: 353 W Standby power consumption (Communication On): 3.8 W Standby power consumption (Communication Off): 0.36 W | | | Operating: 311 W Standby power consumption (Communication On): 3.8 W Standby power consumption (Communication Off): 0.36 W |
| | 220 to 240 V area | Operating: 337 W Standby power consumption (Communication On): 4.3 W Standby power consumption (Communication Off): 0.44 W | | | Operating: 298 W Standby power consumption (Communication On): 4.3 W Standby power consumption (Communication Off): 0.44 W |
| Operating altitude | | Altitude 0 to 2,286 m | | | |
| Operating temperature | | 5 to +35°C (No condensation) | | | |
| Storage temperature | | -10 to +60°C (No condensation) | | | |

| | |
|-------------|----------------|
| Mass | Approx. 3.7 kg |
|-------------|----------------|

| Connectors | Computer1 port | 1 | Mini D-Sub15-pin (female) |
|-------------------|--------------------------|----------|---------------------------------------|
| | Computer2 port | 1 | Mini D-Sub15-pin (female) |
| | DisplayPort | 1 | DisplayPort |
| | Video port | 1 | RCA pin jack |
| | Audio1 port | 1 | Stereo mini jack (3.5Φ) |
| | Audio2 port | 1 | Stereo mini jack (3.5Φ) |
| | Audio-L/R port | 1 | RCA pin jack x 2 (L-R) |
| | Audio Out port | 1 | Stereo mini jack (3.5Φ) |
| | Monitor Out port | 1 | Mini D-Sub15-pin (female) |
| | HDMI port | 1 | HDMI (Audio is only supported by PCM) |
| | USB(TypeA) port*1 | 1 | USB connector (Type A) |
| | USB(TypeB) port | 1 | USB connector (Type B) |
| | LAN port | 1 | RJ-45 |
| | RS-232C port | 1 | Mini D-Sub 9-pin (male) |

*1 Supports USB 2.0. However, USB ports are not guaranteed to operate all devices that support USB.

This product is also designed for IT power distribution system with phase-to-phase voltage 230V.

Angle of tilt

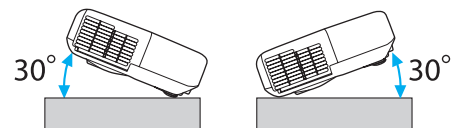

If you use the projector tilted at an angle of more than 30° it could be damaged and cause an accident.

DECLARATION of CONFORMITY

According to 47CFR, Part 2 and 15

Class B Personal Computers and Peripherals; and/or
CPU Boards and Power Supplies used with Class B Personal Computers

We: Epson America, Inc.
Located at: 3840 Kilroy Airport Way
MS: 3-13
Long Beach, CA 90806
Tel: 562-290-5254

Declare under sole responsibility that the product identified herein, complies with 47CFR Part 2 and 15 of the FCC rules as a Class B digital device. Each product marketed, is identical to the representative unit tested and found to be compliant with the standards. Records maintained continue to reflect the equipment being produced can be expected to be within the variation accepted, due to quantity production and testing on a statistical basis as required by 47CFR 2.909. Operation is subject to the following two conditions : (1) this device may not cause harmful interference, and (2) this device must accept any interference received, including interference that may cause undesired operation.

Trade Name: EPSON
Type of Product: LCD Projector
Model: H470C/H470M/H471C/H472C/H473C/
H474C/H490C/H490M/H491C/H504C/
H505C/H506C

**FCC Compliance Statement
For United States Users**

This equipment has been tested and found to comply with the limits for a Class B digital device, pursuant to Part 15 of the FCC Rules. These limits are designed to provide reasonable protection against harmful interference in a residential installation. This equipment generates, uses, and can radiate radio frequency energy and, if not installed and used in accordance with the instructions, may cause harmful interference to radio communications. However, there is no guarantee that interference will not occur in a particular installation. If this equipment does cause interference to radio and television reception, which can be determined by turning the equipment off and on, the user is encouraged to try to correct the interference by one or more of the following measures.

- Reorient or relocate the receiving antenna.
- Increase the separation between the equipment and receiver.
- Connect the equipment into an outlet on a circuit different from that to which the receiver is connected.
- Consult the dealer or an experienced radio/TV technician for help.

WARNING

The connection of a non-shielded equipment interface cable to this equipment will invalidate the FCC Certification or Declaration of this device and may cause interference levels which exceed the limits established by the FCC for this equipment. It is the responsibility of the user to obtain and use a shielded equipment interface cable with this device. If this equipment has more than one interface connector, do not leave cables connected to unused interfaces. Changes or modifications not expressly approved by the manufacturer could void the user's authority to operate the equipment.

Units: mm

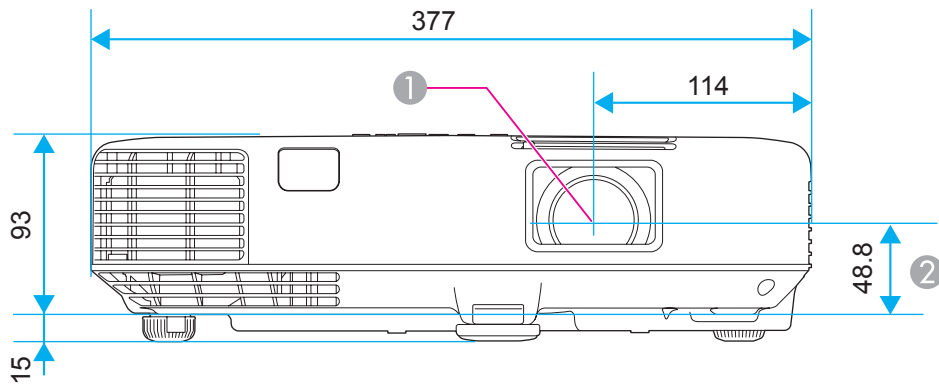

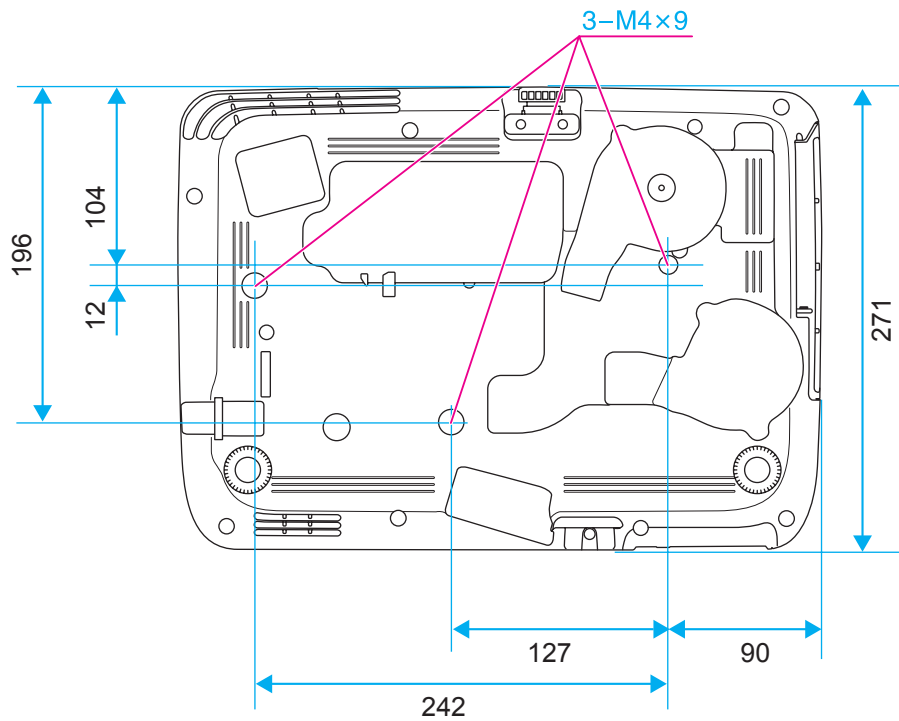

- ① Center of lens
- ② Distance from center of lens to suspension bracket fixing point



This section briefly explains the difficult terms that are not explained in the text of this guide. For details, refer to other commercially available publications.

| | |
|-----------------------------|--|
| Ad hoc mode | A method of wireless LAN connection that communicates with wireless LAN clients without using an access point. |
| AMX Device Discovery | AMX Device Discovery is a technology developed by AMX to facilitate AMX control systems for easy operation of the target equipment. Epson have implemented this protocol technology, and have provided a setting to enable the protocol function (ON). See the AMX Web site for more details. URL http://www.amx.com/ |
| Aspect Ratio | The ratio between an image's length and its height. Screens with a horizontal:vertical ratio of 16:9, such as HDTV screens, are known as wide screens. SDTV and general computer displays have an aspect ratio of 4:3. |
| Component Video | A method that separates the video signal into a luminance component (Y), and a blue minus luminance (Cb or Pb) and a red minus luminance (Cr or Pr). |
| Composite video | A method that combines the video signal into a luminance component and a color component for transmission down a single cable. |
| Contrast | The relative brightness of the light and dark areas of an image can be increased or decreased to make text and graphics stand out more clearly, or to make them appear softer. Adjusting this particular property of an image is called contrast adjustment. |
| DHCP | An abbreviation of Dynamic Host Configuration Protocol, this protocol automatically assigns an IP address to equipment connected to a network. |
| DICOM | An acronym for Digital Imaging and Communications in Medicine. An international standard that defines image standards and a communications protocol for medical images. |
| Gateway Address | This is a server (router) for communicating across a network (subnet) divided according to subnet mask . |
| HDCP | HDCP is an abbreviation for High-bandwidth Digital Content Protection. It is used to prevent illegal copying and protect copyrights by encrypting digital signals sent over DVI and HDMI ports. Because the HDMI port and DisplayPort on this projector supports HDCP, it can project digital images protected by HDCP technology. However, the projector may not be able to project images protected with updated or revised versions of HDCP encryption. |
| HDTV | An abbreviation for High-Definition Television that refers to high-definition systems which satisfy the following conditions. <ul style="list-style-type: none"> • Vertical resolution of 720p or 1080i or greater (p = Progressive, i = Interlace) • Screen aspect ratio of 16:9 |
| Interlace | Transmits information needed to create one screen by sending every other line, starting from the top of the image and working down to the bottom. Images are more likely to flicker because one frame is displayed every other line. |
| IP Address | A number to identify a computer connected to a network. |
| Progressive | Projects information to create one screen at a time, displaying the image for one frame. Even though the number of scan lines is the same, the amount of flicker in images decreases because the volume of information has doubled compared with an interlace system. |

| | |
|------------------------|---|
| Refresh Rate | The light-emitting element of a display maintains the same luminosity and color for an extremely short time. Because of this, the image must be scanned many times per second to refresh the light-emitting element. The number of refresh operations per second is called the Refresh rate and is expressed in hertz (Hz). |
| SDTV | An abbreviation for Standard Definition Television that refers to standard television systems which do not satisfy the conditions for HDTV  High-Definition Television. |
| SNMP | An abbreviation for Simple Network Management Protocol, which is the protocol for monitoring and controlling devices such as routers and computers connected to a TCP/IP network. |
| sRGB | An international standard for color intervals that was formulated so that colors that are reproduced by video equipment can be handled easily by computer operating systems (OS) and the Internet. If the connected source has an sRGB mode, set both the projector and the connected signal source to sRGB. |
| Subnet Mask | This is a numerical value that defines the number of bits used for the network address on a divided network (subnet) from the IP address. |
| SVGA | A screen size standard with a resolution of 800 (horizontal) x 600 (vertical) dots. |
| SXGA | A screen size standard with a resolution of 1,280 (horizontal) x 1,024 (vertical) dots. |
| Sync. | The signals output from computers have a specific frequency. If the projector frequency does not match this frequency, the resulting images are not of a good quality. The process of matching the phases of these signals (the relative position of the crests and the troughs in the signal) is called Synchronization. If the signals are not synchronized, flickering, blurriness, and horizontal interference occur. |
| Tracking | The signals output from computers have a specific frequency. If the projector frequency does not match this frequency, the resulting images are not of a good quality. The process of matching the frequency of these signals (the number of crests in the signal) is called Tracking. If Tracking is not carried out correctly, wide vertical stripes appear in the signal. |
| Trap IP Address | This is the IP address  for the destination computer used for error notification in SNMP. |
| VGA | A screen size standard with a resolution of 640 (horizontal) x 480 (vertical) dots. |
| XGA | A screen size standard with a resolution of 1,024 (horizontal) x 768 (vertical) dots. |

All rights reserved. No part of this publication may be reproduced, stored in a retrieval system, or transmitted in any form or by any means, electronic, mechanical, photocopying, recording, or otherwise, without the prior written permission of Seiko Epson Corporation. No patent liability is assumed with respect to the use of the information contained herein. Neither is any liability assumed for damages resulting from the use of the information contained herein.

Neither Seiko Epson Corporation nor its affiliates shall be liable to the purchaser of this product or third parties for damages, losses, costs, or expenses incurred by the purchaser or third parties as a result of: accident, misuse, or abuse of this product or unauthorized modifications, repairs, or alterations to this product, or (excluding the U.S.) failure to strictly comply with Seiko Epson Corporation's operating and maintenance instructions.

Seiko Epson Corporation shall not be liable against any damages or problems arising from the use of any options or any consumable products other than those designated as Original Epson Products or Epson Approved Products by Seiko Epson Corporation.

The contents of this guide may be changed or updated without further notice.

Illustrations in this guide and the actual projector may differ.

Restriction of Use

When this product is used for applications requiring high reliability/safety such as transportation devices related to aviation, rail, marine, automotive etc.; disaster prevention devices; various safety devices etc; or functional/precision devices etc, you should use this product only after giving consideration to including fail-safes and redundancies into your design to maintain safety and total system reliability. Because this product was not intended for use in applications requiring extremely high reliability/safety such as aerospace equipment, main communication equipment, nuclear power control equipment, or medical equipment related to direct medical care etc, please make your own judgment on this product's suitability after a full evaluation.

About Notations

Microsoft® Windows® 2000 operating system
Microsoft® Windows® XP operating system
Microsoft® Windows Vista® operating system
Microsoft® Windows® 7 operating system

In this guide, the operating systems above are referred to as "Windows 98", "Windows Me", "Windows 2000", "Windows XP", "Windows Vista", and "Windows 7". Furthermore, the collective term Windows may be used to refer to Windows 98, Windows Me, Windows 2000, Windows XP, Windows Vista, and Windows 7, and multiple versions of Windows may be referred to as, for example, Windows 98/Me/2000/XP/Vista, with the Windows notation omitted.

Mac OS X 10.3.x
Mac OS X 10.4.x
Mac OS X 10.5.x
Mac OS X 10.6.x
Mac OS X 10.7.x

In this guide, the operating systems above are referred to as "Mac OS X 10.3.x", "Mac OS X 10.4.x", "Mac OS X 10.5.x", "Mac OS X 10.6.x", and "Mac OS X 10.7.x". Furthermore, the collective term "Mac OS X" is used to refer to them.

Trademarks and Copyrights

IBM, DOS/V, and XGA are trademarks or registered trademarks of International Business Machines Corporation.

Mac and Mac OS are trademarks of Apple Inc.

App Store is a service mark of Apple Inc.

Microsoft, Windows, Windows Vista, PowerPoint, and Windows logo are trademarks or registered trademarks of Microsoft Corporation in the United States and/or other countries.

The DisplayPort Certified Logo and DisplayPort Icons are Registered Trademarks of the Video Electronics Standards Association (VESA).

The word DisplayPort is a Registered Trademark of VESA in various countries around the world.

HDMI and High-Definition Multimedia Interface are the trademarks or registered trademarks of HDMI Licensing LLC. The logo for HDMI (High Definition Multimedia Interface) consists of the word "HDMI" in a bold, black, sans-serif font. Below the letters "I" and "M", the words "HIGH DEFINITION MULTIMEDIA INTERFACE" are written in a smaller, all-caps, sans-serif font.

PJLink trademark is a trademark applied for registration or is already registered in Japan, the United States of America and other countries and areas.

Foxit PDF SDK Copyright ©2011, Foxit Software Company www.foxitsoftware.com, All rights reserved.

Other product names used herein are also for identification purposes only and may be trademarks of their respective owners. Epson disclaims any and all rights in those marks.

©SEIKO EPSON CORPORATION 2012. All rights reserved.

A

| | |
|-------------------------------------|--------|
| A/V Mute | 61 |
| Abs. Color Temp. | 88 |
| Air exhaust vent | 11 |
| Air filter replacement period | 125 |
| Aspect | 44, 90 |
| Audio Input | 92 |
| Auto Iris | 44, 88 |
| Auto Setup | 89 |
| Auto V-Keystone | 90 |

B

| | |
|------------------|----|
| Basic menu | 95 |
| Blackboard | 43 |
| Brightness | 88 |

C

| | |
|---|--------|
| Ceiling | 20, 92 |
| Ceiling mount fixing points | 13 |
| Cleaning | 119 |
| Cleaning the air filter and air intake vent | 119 |
| Cleaning the Projector's Surface | 119 |
| Color Adjustment | 88 |
| Color Mode | 43, 88 |
| Color Saturation | 88 |
| Computer Port | 12 |
| Configuration menu | 85 |
| Consumables | 129 |
| Continuous | 60 |
| Contrast | 88 |
| Control panel | 14 |

| | |
|--------------------------|--------|
| Control Panel Lock | 72, 90 |
| Crestron RoomView | 80 |
| Cross | 63 |

D

| | |
|--------------------------|-----|
| DICOM SIM | 43 |
| Direct Power On | 92 |
| Display | 92 |
| Display Background | 92 |
| Display order | 60 |
| Display Settings | 60 |
| DisplayPort | 12 |
| Distance | 130 |
| Document Camera | 128 |
| Dynamic | 43 |

E

| | |
|----------------------|----|
| EasyMP Monitor | 74 |
| Email Address | 97 |
| ESC/VP21 | 78 |
| Extended menu | 91 |
| E-Zoom | 63 |

F

| | |
|-----------------------------|--------|
| Focus ring | 11 |
| Foot adjust lever | 11 |
| Freeze | 61 |
| Front | 20, 92 |
| Front adjustable foot | 11 |
| Full Lock | 72 |

G

| | |
|-----------------------|----|
| Gateway Address | 96 |
|-----------------------|----|

H

| | |
|-------------------------------------|-----|
| HDMI port | 12 |
| HDMI Video Range | 89 |
| Help function | 102 |
| High Altitude Mode | 92 |
| H-Keystone Adjuster | 90 |
| How to replace the air filter | 125 |
| How to replace the lamp | 122 |

I

| | |
|--------------------|--------|
| Image menu | 87 |
| Indicators | 104 |
| Info menu | 99 |
| Input Signal | 90, 99 |
| IP Address | 97 |

K

| | |
|----------------|----|
| Keystone | 90 |
|----------------|----|

L

| | |
|-------------------------------|-----|
| Lamp cover | 11 |
| Lamp hours | 99 |
| Lamp indicator | 104 |
| Lamp replacement period | 121 |
| Language | 93 |
| Lens Cover Timer | 92 |

| | |
|---|----------|
| M | |
| Mail Notification | 76, 97 |
| Mail Notification menu | 96 |
| Message Broadcasting | 74 |
| Messages | 92 |
| Monitor Displays | 133 |
| Mouse pointer | 64 |
| Multi-screen | 65, 93 |
| N | |
| Network Configuration | 93 |
| Network information | 93 |
| Network menu | 93 |
| Noise Reduction | 89 |
| O | |
| Operating temperature | 135 |
| Operation | 92 |
| Optional accessories | 128 |
| Overheating | 105 |
| P | |
| Part Names and Functions | 11 |
| Password protect | 70 |
| Password protect sticker | 71 |
| Pattern | 91 |
| Photo | 43 |
| PJLink | 79 |
| PJLink Password | 95 |
| Pointer | 62 |
| Pointer Shape | 91 |
| Port Number | 97 |
| Position | 89 |
| Power Consumption | 91 |
| Power indicator | 104 |
| Power inlet | 12 |
| Power On Protect | 70 |
| Presentation | 43, 53 |
| Problem Solving | 104 |
| Progressive | 89 |
| Projection | 92 |
| Projector ID | 66, 92 |
| Projector keyword | 95 |
| Projector Name | 95 |
| Projector Setup | 74 |
| Q | |
| Quick Corner | 90 |
| R | |
| Reading Mail | 77 |
| Rear | 20, 92 |
| Rear feet | 13 |
| Rear screen | 20 |
| Refresh Rate | 99 |
| Remote control | 15 |
| Remote receiver | 11, 12 |
| Replacing batteries | 17 |
| Reset All | 100 |
| Reset menu | 99, 100 |
| Resetting the lamp operating time | 100, 125 |
| Resolution | 99 |
| RoomView | 80 |
| Rotating images | 55 |

| | |
|----------------------------------|--------|
| S | |
| Screen Size | 51 |
| Screen size | 130 |
| Screen switching time | 60 |
| Select Drive | 55 |
| Settings menu | 90 |
| Sharpness | 88 |
| Signal menu | 88 |
| Sleep Mode | 92 |
| Slideshow | 54, 58 |
| SMTP Server | 97 |
| SNMP | 77 |
| Soft keyboard | 94 |
| Source | 50, 99 |
| Source Search | 14, 31 |
| Specifications | 135 |
| Split Screen Setup | 50 |
| Sports | 43 |
| sRGB | 43 |
| Standby Mode | 92 |
| Startup Screen | 92 |
| Storage temperature | 135 |
| Subnet Mask | 96 |
| Supported Monitor Displays | 133 |
| Swap Screens | 51 |
| Sync Info | 99 |
| Sync. | 89 |
| T | |
| Temp indicator | 104 |
| Theatre | 43 |
| Tint | 88 |
| Tracking | 89 |

U

| | |
|---------------------------|----|
| USB(TypeA) port | 12 |
| USB(TypeB) port | 12 |
| User Button | 91 |
| User's Logo | 68 |
| User's Logo Protect | 70 |

V

| | |
|---------------------|--------|
| Video Port | 12 |
| Video Signal | 90, 99 |
| Volume | 91 |
| Volume Button | 14 |

W

| | |
|-------------------------------|----|
| Web Browser | 74 |
| Web Control | 75 |
| Web Control Password | 95 |
| Web Remote | 75 |
| Whiteboard | 43 |
| Wired LAN menu | 96 |
| Wireless mouse function | 64 |

Z

| | |
|-----------------|----|
| Zoom ring | 11 |
|-----------------|----|